

STRATEGIC MANAGEMENT AND
ENTREPRENEURSHIP AS ECONOMIC DEVELOPMENT TOOLS

by

NORBERT L. ZIEMER II

A DISSERTATION

Presented to the Faculty of the Graduate School of the
MISSOURI UNIVERSITY OF SCIENCE AND TECHNOLOGY

In Partial Fulfillment of the Requirements for the Degree

DOCTOR OF PHILOSOPHY

in

ENGINEERING MANAGEMENT

2012

Approved
Suzanna Long, Advisor
William Daughton
Elizabeth Cudney
Ralph Hanke
Robert Montgomery
John Lewis

UMI Number: 3553285

All rights reserved

INFORMATION TO ALL USERS

The quality of this reproduction is dependent upon the quality of the copy submitted.

In the unlikely event that the author did not send a complete manuscript and there are missing pages, these will be noted. Also, if material had to be removed, a note will indicate the deletion.



UMI 3553285

Published by ProQuest LLC (2013). Copyright in the Dissertation held by the Author.

Microform Edition © ProQuest LLC.

All rights reserved. This work is protected against unauthorized copying under Title 17, United States Code



ProQuest LLC.
789 East Eisenhower Parkway
P.O. Box 1346
Ann Arbor, MI 48106 - 1346

© 2012

Norbert L. Ziemer

All Rights Reserved

ABSTRACT

This research develops a framework of Biobased Entrepreneurial Ventures for Rural Economic Development. Rural economic development poses unique challenges and opportunities, based on available production assets, workforce trends like “brain drain,” and access to industry clusters. However, certain entrepreneurial venture opportunities are preferable for rural economic development. Since supply chains are vital to business success, initial emphasis is placed on the biomass resource base to be transformed through entrepreneurial activity into higher economic value outputs.

The literature contains research on specific opportunities in rural economic development (e.g. ethanol, wind power). Many of these are limited in scope and depend on economies of scale. Thus, there is an opportunity for a framework offering utility for evaluating entrepreneurial ventures with biomass as a strategic resource.

This research integrates three case studies which have been developed for publication. Case 1 features a regional scale biodiesel operation utilizing a flexible feedstock process technology with used cooking oils as a primary input. Case 2 presents a biomass opportunity with algae being harvested from a large wastewater treatment facility. Case 3 examines a prominent food processor’s cucumber co-product fractions. These cases help illustrate a variety of factors, conditions and forces that a new venture may encounter. The cases are representative of a range of biobased entrepreneurial ventures with relevance for rural economic development. The resulting framework provides a basis for evaluating future opportunities based on defining characteristics and attributes, as well as entrepreneurial dynamics and regional factors.

ACKNOWLEDGMENTS

I would like to thank my advisor, Dr. Suzanna Long, for all of her guidance, support and insights throughout this process. Dr. Long and the members of my doctoral committee helped me refine my work and tighten the scope. I appreciate the perspective and suggestions shared by Dr. Long and the committee: Dr. William Daughton, Dr. Elizabeth Cudney, Dr. Ralph Hanke, Dr. Robert Montgomery and Dr. John Lewis.

I am grateful for my colleagues at Northern Illinois University (NIU), including Diana Robinson, Lisa Bergeron, Drs. Anne Kaplan, Norman Walzer, Robert Tatara, Gabe Holbrook, Scott Grayburn, Brian Mackie, Gerry Aase, Chang Liu and others who have lent their support and their counsel.

The Belvidere-Boone County Growth Dimensions AgTech Initiative provided inspiration and foundations from which my research germinated. Thanks to Mark Williams, Mayor Fred Brereton, Greg Brown and others for your visionary leadership. The State of Ingenuity collaborative, with NIU and University of Wisconsin-Whitewater as partners, also provided seeds that fed my research. Regional stakeholders (Steve Graceffa, Jun Yoshitani, et al.) and entrepreneurs shared information; your inputs helped me solidify key thoughts on entrepreneurship, innovation, and economic development.

I appreciate support from colleagues including Drs. Fred Hadley and Joseph Ward (Rockford College), Dr. Therese Fellner (Gateway Technical), Dr. Kurt Rosentrater and Bailey Richardson (Iowa State) and my doctoral student colleagues at Missouri S&T.

Finally, thanks to my family and friends for their patience and encouragement in this endeavor. I realize sacrifices were made to get to this point. I appreciate it!

TABLE OF CONTENTS

	Page
ABSTRACT.....	iii
ACKNOWLEDGMENTS	iv
LIST OF ILLUSTRATIONS.....	vii
LIST OF TABLES	ix
SECTION	
1. INTRODUCTION	1
1.1. MOTIVATIONS FOR STUDY.....	1
1.2. STATEMENT OF PURPOSE AND RESEARCH QUESTIONS.....	2
1.2.1. Regional Economic Development Strategies	5
1.2.2. Collaboration as it Relates to Biomass.....	5
1.2.3. Challenges	7
1.2.4. Technology Entrepreneurship	7
1.2.5. Biomass Technology Business Development	9
2. FOUNDATIONAL THEORY AND LITERATURE REVIEW	11
2.1. INTRODUCTION	11
2.2. ABOUT ENTREPRENEUR DEVELOPMENT	12
2.2.1. Entrepreneur Defined	12
2.2.2. Innovation Defined	13
2.2.3. Engagement in Innovation and Entrepreneurship	13
2.2.4. Trends in Innovation and Entrepreneurship	14
2.3. ESTABLISHING LINKAGES BETWEEN CAPITAL RESOURCES	14
2.3.1. A New Uses Entrepreneur Development Center Approach	15
2.3.2. Core Design and Model Framework	16
2.3.3. Network Ties	19
3. FRAMEWORK DEVELOPMENT AND METHODOLOGY	23
3.1. RURAL ECONOMIC DEVELOPMENT AND NEW VENTURES	23

3.1.1. Who, What and How	24
3.1.2. Analytical Approaches	24
3.1.3. Biomass Utilization	25
3.2. FRAMEWORK FOR BIOMASS-BASED ENTREPRENEURIAL VENTURES	26
4. THREE CASES FOR THIS RESEARCH	30
4.1. CASE 1: REGIONAL BIODIESEL.....	30
4.1.1. Impact Analysis for Economic Development	39
4.1.2. Biodiesel Co-Product Opportunities: Glycerol	40
4.1.3. Direct Use Opportunities: Thermal Energy	43
4.1.4. Direct Use Opportunities: Dust Control	44
4.2. CASE 2: ALGAL BIOMASS FROM WASTEWATER TREATMENT.....	44
4.3. CASE 3: CUCUMBER STOCK.....	58
4.3.1. Introduction to Cucumber Case	59
4.3.2. Background and Reference	61
4.3.3. Densification	63
4.3.4. Nutritional Composition	63
4.3.5. Food	65
4.3.6. Feed	65
4.3.7. Alcohol Fuel Applications	66
4.3.8. Anaerobic Digestion	66
4.3.9. Biobased Fertilizer and Compost	67
5. SYNTHESIZING AND INTEGRATING RESULTS	69
5.1. EXPANDING THIS EFFORT TO FUTURE OPPORTUNITIES.....	69
5.1.1. Collaboration, Alliances and Resource Synergies	71
5.1.2. Business Matching and Networks	72
5.1.3. Audio and Video Capture	75
5.1.4. Site Visit	77
5.1.5. Information System for Matching	80
6. LIMITATIONS OF THIS STUDY	81

7. SYNTHESIZING AND INTEGRATING RESULTS	83
7.1.SUMMARY.....	83
7.2.RECOMMENDATIONS.....	85
7.3.IMPLICATIONS FOR ENGINEERING MANAGERS.....	86
7.4.CONTRIBUTIONS TO THE LITERATURE.....	87
7.5.FUTURE RESEARCH.....	88
APPENDIX.....	89
BIBLIOGRAPHY.....	113
VITA.....	120

LIST OF ILLUSTRATIONS

Figure	Page
1.1: Diagram of Complementary Development Spheres	7
2.1: Organizational Network Linkage Mapping.....	15
2.2: Core Design of Distributed Entrepreneurship Center	18
2.3: Distributed Business Incubator Model.....	20
3.1: Biomass Inputs, Outputs, and Co-Products.....	25
3.2 Framework of Biobased Ventures for Rural Economic Development	26
3.3: Strategic Output Alternatives for Biomass	29
4.1: Framework of Biobased Entrepreneurial Ventures for Biodiesel	32
4.2: Cost Curve.....	33
4.3: Base Case of Biodiesel Venture Simulation	38
4.4: Biodiesel Venture Simulation with Lower Cost Feedstock	39
4.5: Annual U.S. Biodiesel Production, Millions of Gallons	40
4.6: Framework for Algal Biomass at Water Treatment Plant.....	45
4.7: Algae Occurring Naturally within Raceways at Water Facility.....	47
4.8: Filamentous Algae Harvested at Water Facility, Initial Moisture Reduction	49
4.9: Lipid Concentration under Microscope	50
4.10: SuperPro Process Diagram	52
4.11: Compiled Results for Algal Biomass Scenario Analyses	56
4.12: Framework of Cucumber Biomass at a Food Processing Facility.....	60
4.13: Nutritional Composition, Cucumber	64

LIST OF TABLES

Table	Page
4.1: Strategic Outcome Options, Alternate Oil Based Biodiesel Supply Chain.....	35
4.2: Strategic Outcome Options for Canola Based Biodiesel Supply Chain.....	48
4.3: Strategic Outcome Options for Cucumber Biomass Supply Chain.....	62
4.4: Laboratory Analysis for Cucumber Stock	65

1. INTRODUCTION

1.1 MOTIVATIONS FOR STUDY

The birthing of new business opportunities is essential to economic development and longer-term vitality of a community or region. Entrepreneurship and strategic management of technology play instrumental roles in establishing these innovative opportunities as well as in sustaining them following their initial founding. This new development for spurring economic activity can take place in a variety of ways: establishing new startup businesses, attracting organizations from other regions, and growing existing local/regional businesses through new market opportunities. Some key elements work in favor of a geographical region seeking to encourage growth in economic activity. These desirable elements include the available asset base, the region's productive capacity and any specific skills and expertise that help differentiate the region within the competitive market space. The significance of supporting small and medium sized enterprises as part of a comprehensive strategic development strategy has been well documented (Birch, 1987).

This research focuses on biobased entrepreneurial ventures for rural economic development. Strategic technology management and entrepreneurship can be economic development tools for the purpose of increased regional economic vitality, new value creation and the preservation and prudent utilization of existing resources. Three key elements will be highlighted: biomass resources and supply chains, business innovation and operations, and strategic entrepreneurial activity. It develops a framework for evaluating new use opportunities for biomass ventures.

The literature suggests that rural areas present unique challenges to new development opportunities. As Walzer (2007) explains, rural areas have generally experienced a significant restructuring with higher paying manufacturing employment giving way to lower-paying employment in the service sector. High school graduates often leave such rural areas for more lucrative opportunities, and may later find that there are not enough incentives to return back to that rural setting later in life. Although rural community leaders and economic development professionals may realize that the youth represent future vibrancy and vitality for rural communities, such leaders often are uncertain how to effect change in the local economic climate in order to deal with this (Walzer, 2007).

At the same time, these geographical regions may be home to prime agricultural capabilities as well as additional resources (e.g. human talent) essential to the conversion of biomass inputs into higher value outputs and products. This investigation examines the opportunities for technology based economic development which may be realized by through innovation and strategic leveraging of rural supply chains. A case study approach is employed (Eisenhardt, 1989).

1.2 STATEMENT OF PURPOSE AND RESEARCH QUESTIONS

There has been much attention recently on the subject of economic development and the process of how to spur entrepreneurship and new business development. This is important in wide range of geographically defined areas of study. This research emphasizes technology centric entrepreneurship which is vital to higher paying manufacturing, technology and operations type employment opportunities. It focuses

more closely on the economic development in and near rural areas. These geographies inherently hold key resources and certain factors which may provide advantageous to specific biobased opportunities and their associated value chain processes.

This effort recognizes current standard practices and methods used in economic development. One approach is the attraction of new business enterprises through perks such as tax deferments and incentive packages. The competition is intense between regions in search of job creation opportunities and increased economic activity. Additionally, regions and communities utilize business retention and expansion strategies for economic development; this involves efforts to retain and support existing business organizations that already positively impact the community, and to help existing firms expand their current business operations in that particular geographical location. Sometimes these approaches leave much to be desired in terms of how to vet technical opportunities, evaluate for new entrepreneurial approaches, and incorporate key geographical and community-specific attributes and resources.

This research probes the question of “How can the process of establishing new biomass ventures for rural economic development be improved?” Or, to state this another way, “How can biomass venture opportunities be incubated?” To address this, the author develops a framework for identifying and evaluating a wide range of biomass related new venture opportunities which may be considered for entrepreneurial development. Three distinctly different cases involving biomass are investigated using the framework.

In the course of using the framework of this research for exploring and evaluating biomass related ventures for rural economic development, certain key factors are given consideration:

- To what innovative uses does a certain biomass supply lend itself?
- How does the biomass supply chain characterization lead to new use opportunity realms?
- What additional (external) factors may play a role in the economic value proposition of a certain biomass project?
- How should an entrepreneur or developer approach entrepreneurial opportunities for creating biobased products and/or ventures?
- What role do information systems and strategic information management play in helping increase the likelihood of biobased entrepreneurship?
- How will this framework facilitate future opportunities that may differ significantly?
- Are there policy factors to be considered?
- Are there regulations currently in place? If so, how might changes in this area impact the biomass venture?
- Are there other externalities (e.g. subsidies, tax credits) upon which the venture's success may depend?
- What is the role of technology in rural economic development?
- How may the support of experts and academic institutions impact such technology based economic development?

1.2.1. Regional Economic Development Strategies. Recent trends toward local and regional collaboration have resulted in growing interest in regional approaches to economic development. Here, counties and geographically defined footprints which may have previously been direct competitors are exploring opportunities to become more interactive through collaboration with the goal of increased economic activity. One such example is the State of Ingenuity which is located in the Stateline region of Wisconsin and Illinois. The State of Ingenuity initiative includes four counties in southern Wisconsin and two counties in northern Illinois. This is an important distinction from previous economic development models which are often parochial and very limited by territory. Here, the collaboration crosses not only county lines but also state borders. This initiative is one of the more forward looking approaches to implementing a systems approach to economic development.

This collaborative approach may lead to the development of focused economic clusters within a swept region. Ultimately, this type of activity may enable a region to become well known for certain expertise and capabilities (e.g. medical technologies, rural healthcare, information technology, etc.). The region can emerge into a hotspot of economic activity for key strategic focal areas.

1.2.2. Collaboration as it Relates to Biomass. New venture development in biomass may lend itself well to regional approaches. While key technological breakthroughs might be held as intellectual property, much of the remainder of the venture can be looked at more collaboratively rather than competitively. For example, the supply chain to feed the biomass operation is so crucial to a new venture establishment and continued operation, and thus a concerted regional approach may serve

this need well. Additionally, since biomass typically does not have a high enough density to warrant shipping over long distances, it is likely that supply chain systems and processes will be developed around distributed centers of biomass conversion into new use opportunities. Some collaborative models such as cooperatives involving agricultural producers as key stakeholders have been used with considerable success.

Economic development is associated with community development. The integrated relationships are depicted in Figure 1.1. Walzer (2012) explains that these are not separate or competing elements but that they are interrelated. Walzer (2012) further asserts that community development builds the foundational capacity which help economic development practices occur more efficiently. So, community development may appear in areas like high caliber educational systems, high quality housing, and good infrastructure (broadband, healthcare, transportation, etc.). Economic development has more of a focus on supporting employment and income generation (business growth and retention, entrepreneurship, etc.) and expanding the tax base. The business development sphere hones in on private sector ventures such as manufacturing and service business growth. The industrial development area is more focused on firms that typically export finished goods from the region.

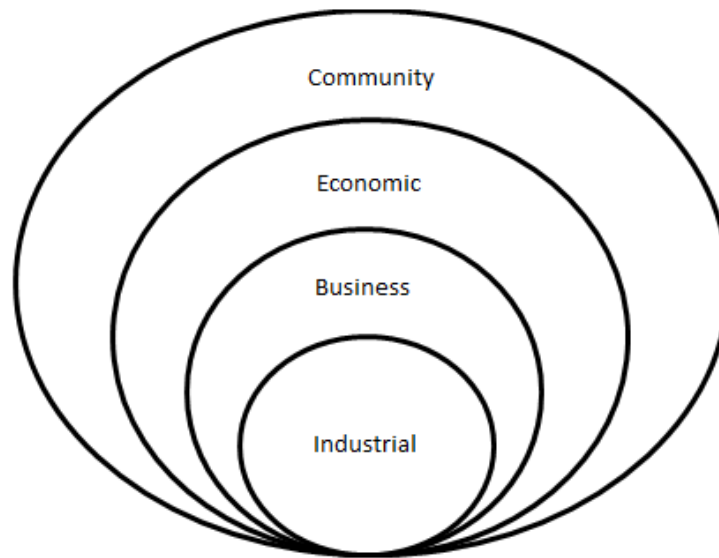

Figure 1.1: Diagram of Complementary Development Spheres (Walzer, 2012)

1.2.3. Challenges. Development projects face certain challenges. Often, infrastructure development efforts like transportation projects (roads, bridges) may promise long term benefits and create pathways for follow-on opportunities (Rangarajan et al., 2009b), however, they may be difficult to justify from a financial investment standpoint (Rangarajan et al., 2009a).

1.2.4. Technology Entrepreneurship. One of the more exciting and dynamic arenas for engineering managers is that of technology based entrepreneurship, an area emphasizing the linkages between innovation and entrepreneurship (Hebert et al., 2006). Here, it is not basic scientific breakthrough in and of itself but rather, the application of new technologies into product and system innovations which can provide competitive advantages in the marketplace. It is important to recognize the distinctions between

market orientation and technology push approaches (Little et al., 1972). The efforts toward effective new product development and innovation may play important roles in economic activity, through knowledge spillovers and synergistic cross-pollination (Henderson et al, 2005).

Shane (2005) explores entrepreneurship and identifies key factors that correlate with the success of new ventures, with a focus on technology entrepreneurship. Shane goes on to state that roughly 4 percent of the U.S. labor pool is involved in starting a new enterprise during every years. Within the first year of startup, 40 percent of these businesses have failed; approximately two-thirds of them cease to exist in less than 5 years. However, the data show that technology centric startups enjoy a more favorable likelihood of success than non-technology companies. Here, the term technology is used in a holistic sense to include the creation and deployment of new products and materials, new market opportunities and process innovations.

It may then be that one of the desirable core competences is the ability to repeatedly and under unique conditions, develop such synergies at the intersection of the business and entrepreneurial side of the marketplace and the knowledge and technology side rooted in academia. This combination may be modeled or viewed as an intersection of two key realms: 1) discovery and knowledge creation in science and technology/engineering, and 2) market opportunities and strategic marketing/management. The intersection of these competencies and complementary assets may facilitate and accelerate the process of moving academic research from the basic science level at the academic institution toward introduction and scale up into new markets. This may help a startup to satisfy key functions necessary for business survival (Drucker, 1958).

1.2.5. Biomass Technology Business Development. This research addresses the strategic role of agricultural and biomass supply chains in current and emerging entrepreneurial opportunities. It is unique in that it focuses on technology based enterprises, which in itself is a type of differentiation strategy (Porter, 1998). Additionally, the connection to biomass resource bases makes it a natural fit for rural regions. The research develops and tests a framework for how better to explore new biomass related opportunities and to encourage entrepreneurship and economic development around these innovations.

As Ruttan (2001) asserts, the societal impacts of new technology are realized only upon the adoption and use of such breakthroughs. Ziemer and Long (2009) discuss the importance of strategic technology partnerships for advancing entrepreneurship and technology based economic development, citing March's work on exploration and exploitation (1991). Academic institutions can serve as vital partners by means of targeted research, subject matter expertise, market information, and more. At the same time, the academic institution is less likely to be the entity to ultimately commercialize a new technology, a fact which underscores the synergism in partnering with an entrepreneur or an entrepreneurial organization to undertake the commercialization process. The community or region is also a strategic stakeholder in this collaboration with a range of interests including new enterprise development, job creation, increased economic activity, high caliber workforce development, and more.

The organizational network underpinning such a collaborative represents a critical mass of expertise, network connections, and intellectual horsepower. This bundled expertise and capital enables the collaborative and its respective stakeholders to play a

leadership role in the introduction of new technologies and business models that will ultimately participate in the market space related to bioenergy and biobased products. One strategic approach is to assess what resources are available. These resources may vary from basic inputs or building blocks, for example the biomass feedstocks that may feed a bioenergy conversion process. Another resource that may lend to this innovation could be a special technology, piece of equipment, or system which would be instrumental in the value adding conversion process.

There may be manufacturers, machine shops and other industrial firms that possess technical expertise and physical capital to positively impact a new system. Alternatively, these manufacturers may have an unmet need or inefficient method to their current operations which may benefit from biomass resource integration. This could be as an energy input or as a base biological, chemical, or physical input for production and operations.

So, a question is raised as to what those resources can be used to do that they are currently not doing? Can the resources be re-purposed, re-configured, re-shaped, etc.? A number of different strategies may apply here, and there will be some degree of uniqueness to different product and process opportunities.

2. FOUNDATIONAL THEORY AND LITERATURE REVIEW

2.1 INTRODUCTION

The topic of rural economic development is a growing concern. Rural areas face particular challenges, including aging demographics, underemployment, and varying approaches to developing long range strategies. At the same time, rural areas are places of commerce and living. Some rural areas are developing comprehensive growth plans that include farmland preservation strategies that often include new uses and value adding applications for the biomass products raised on such lands.

To begin, a cursory review of assets and resources in rural geographies will help to inform decision makers of new opportunities. The resources may be human capital and workforce attributes, as well as other elements unique to a particular region. Biomass is often a resource that is abundantly present in rural settings, which holds potential for conversion into products and economic value that may be delivered to market.

Entrepreneurs convert and rearrange resources in order to increase the overall value (Gwartney et al., 2000). This is often done through new products although it can take the form of services and even new business models. Gwartney et al. go on to say that it is the business of the entrepreneur to determine which projects will be profitable. Central to entrepreneurship is the innovation process, in which something new is created (Barringer & Ireland, 2006). A number of factors such as increased global economic globalization have further propelled entrepreneurship and entrepreneurial activity (Stearns & Hills, 1996).

Opportunity recognition literature has covered some elements relevant to this research. However, there are certain key differences to technology based entrepreneurship. It really requires a firm foundation on the science and technological aspects while at the same time and understanding of business and the market landscape. Either on its own is necessary but not sufficient.

There are additional factors to be considered with biomass ventures for economic development. The geographical location provides certain advantages. For example, the Midwest is generally strong in agricultural production capacity. Much of this has to do with climate, water availability, soil fertility and overall terrain. In addition to the agricultural productivity aspects, the Midwestern location provides logistical advantages. The relatively central positioning in the United States lends itself to quick access to key supply chain nodes. For example a producer near Rockford, IL will enjoy access to major interstate routes, an intermodal hub as well as rail and water transportation channels. This can translate into distribution channels into prominent markets like Chicago, Madison, Milwaukee, St. Louis and other markets.

2.2 ABOUT ENTREPRENEUR DEVELOPMENT

2.2.1. Entrepreneur Defined. There are various interpretations and implications associated with the term “entrepreneur.” There is even healthy debate about this in the literature. Some experts include small business owners and family business proprietors; other experts prefer criteria that include high growth and more serial, dynamic activity in their definitions of entrepreneurs. “Entrepreneurs are risk bearers” (Low et al., 2005) - “They decide when to innovate, what innovations to adopt, how far to push the

innovative changes in their business, and how to acquire and bundle resources to build success in the marketplace”

2.2.2. Innovation Defined. “Innovation is widely regarded as a key ingredient in business success” (Rogers, 2004). Rogers further asserts that “an initial aspect of the innovation process is the ability of the firm to generate “new” ideas, where “new” means new to the firm, but not necessarily new to the wider economy.” Sources of innovation may include formal research, customer suggestions, observations of the world, creativity of employees and more.” Cohen & Levinthal (1990) asserted that the ability of a firm to recognize and synthesize new information from external sources is essential the innovative capacities of the firm.

2.2.3. Engagement in Innovation and Entrepreneurship. The United States has been known for the innovative abilities both of its citizens and of newcomers in search of new entrepreneurial opportunities. In today’s dynamic and challenging global economy, where change is continuous and new business models emerge rapidly, the need to be entrepreneurial and innovative in order to compete will only continue to grow. New business introduction, which often begins with small business, plays a key role in economic development.

Innovation is a specific tool used by entrepreneurs. In the entrepreneurship literature, innovation is coupled with the ability to derive economic value (Hills, 1994). Drucker (1986) expanded on this by describing innovation as the means by which entrepreneurs “exploit change as an opportunity for a business or a different service.” Therefore, new ways of bundling elements of existing business processes and models may be capable of effecting the “creative destruction” outcomes Schumpeter described

(Schumpeter, 2002). Strategic economic development initiatives, including industry-university collaboration, may help increase the ability of entrepreneurs to develop successful new products and ventures. These successes may be realized through the increased access to key information and contacts.

2.2.4. Trends in Innovation and Entrepreneurship. Schumpeter (2002) espoused the importance of the entrepreneur and innovation as fundamental to business success, and he further asserted that economic development occurs when firms engage in entrepreneurship –launch new products, production processes and organizational techniques. The innovation that is driven by entrepreneurs has an important impact on the market and on the overall economic fitness and performance of the free market system, much of this through small business activity. According to the National Federation of Independent Business (NFIB), small businesses in the United States produce approximately half of the private Gross Domestic Product and between 60% and 80% of net new jobs. From 2004 to 2005, the number of new employing small businesses increased 4.5%. At any given time, approximately 6-7% of the United States population is in the process of starting a business, according to the NFIB. Therefore, it follows logically why communities and their respective economic development arms strive to increase the rate of new entrepreneurial venture launches.

2.3. ESTABLISHING LINKAGES BETWEEN CAPITAL RESOURCES

Strategic economic development efforts such as collaboration networks help leverage the strength of social networks in building linkages between entrepreneurs,

organizations, scientists and researchers (Figure 2.1). Bourdieu (1986) described three types of capital –economic capital, cultural capital, and social capital. Strategic economic development efforts for entrepreneurship may help reduce the gaps and actually increase the connectivity between the three types of capital. Such an initiative may do this by a network of connections which, with current information technology and professional social networking, may grow exponentially. This may increase synergistic connectedness and enhance information exchange.

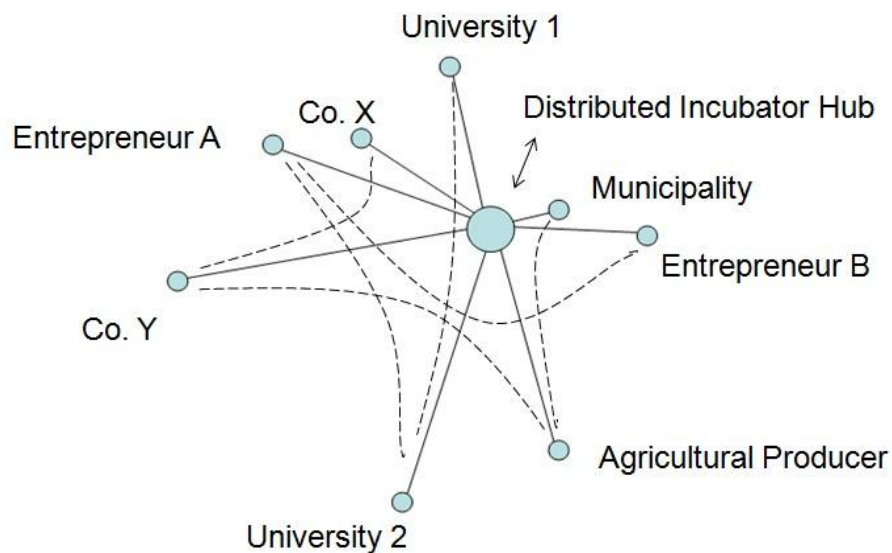

Figure 2.1: Organizational Network Linkage Mapping (adapted, Ziemer & Long, 2010)

2.3.1. A New Uses Entrepreneur Development Center Approach. The AgTech

Initiative is part of a comprehensive growth plan, founded by Growth Dimensions, the

economic development agency for Boone County in northern IL (AgTech Initiative, 2012). AgTech has a strategic focus on a specific sector, namely the burgeoning area of “green” business development. The New Uses Information and Entrepreneur Development Center, the core of AgTech, is an example of a networked incubator (Bollingtonft et al., 2005), and has provided awareness of and impetus for conducting this research.

For some, the “green” term is more of a catchphrase than a distinct basis for strategic differentiation. However, there is a base which has recognized the area to hold potential for leveraging competitive advantages and exploiting technological prowess. The latter may more accurately define the “green” development area in terms of industrial biotechnology. This industrial biotechnology realm includes intellectual property and knowledge assets related to innovative uses for biobased supply chain inputs.

A number of economic forces are helping shape new opportunities and growing demand for biobased technological solutions: efforts toward increased environmental stewardship, growing global energy requirements, volatile price movements in energy commodities, and petroleum dependency reduction strategies.

2.3.2. Core Design and Model Framework. Figure 2.2 outlines the key components in the distributed incubator core design. The central core is a business intelligence engine which draws inputs from technological expertise from academic institutions, subject matter experts and researchers, as well as regional organizations such as industrial firms, economic development organizations and the community as a whole. Entrepreneurs linking with the distributed or networked incubator are able to avail

themselves of key information and strategic contacts that may lead to increased likelihood of the successful launching of new business upstarts in the industrial biotechnology and renewable energy areas. This incubator is unique in that it leverages many of the benefits of bricks and mortar incubators, while at the same time minimizes many of the disadvantages and weaknesses of physical incubators. The distributed incubator is type of complex adaptive system in that it grows and evolves through time. It is less bounded by geographical limitations and can thus draw benefits from linkages to nodes of unique expertise that are further away. This type of system has the ability to capture and compile information in a strategic manner such as to help in the identification of new opportunities. In doing so, this system will enable the exploitation of information asymmetries. It also addresses the reality of bounded rationality of humans. In the case of biomass ventures, in which supply chain factors are such critical considerations, this system will help in the identification of new biomass sources and will allow these to develop in an emergent manner (Choi et al., 2001).

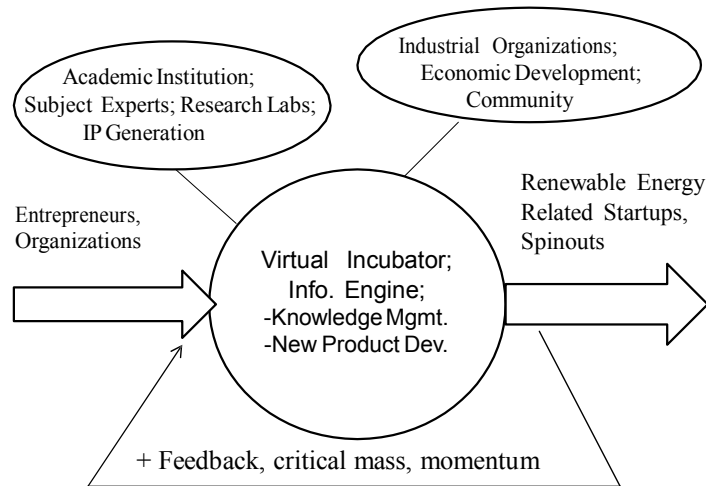

Figure 2.2: Core Design of Distributed Entrepreneurship Center

For the biodiesel project, the venture management team principals gave an early stage presentation of the imminent business case. This step is indicated at the inlet arrow on the left hand side of the visual model in Figure 2.2. The process continued with further discussions, project screening and review, business plan revision and additional refinement. AgTech and the economic development organization increased the entrepreneurs' access to local/regional contacts and support organizations. These included both upstream and downstream supply chain partners (e.g. potential stakeholders, agricultural producers, academic researchers and subject experts, investors, and future customers). These steps were helpful both in strategic planning and market and supply chain development.

The biodiesel case in this research aligns well with the overall objectives of the AgTech Initiative as a tool for technology based economic development in that a biodiesel venture meets the objectives for: spawning new economic activity and

business creation/growth, expanding workforce opportunities, increasing market channels for agriculturally-derived products, and contributing to the long term development of the region as a hotspot for biobased innovation activity.

As Pernick and Wilder (2008) assert, there are a few key actions that may play a significant role in accelerating the developments by a regional clean tech initiative. These actions include providing the following: access to capital, Research & Development (R & D) support, workforce talent, supportive policies, and vision. The R & D support can be fostered through collaboration with university and government labs, as they provide access to human capital in the form of science and engineering talent.

The business incubator may effectively serve a role as a broker who helps bring together agents who may have potential collaborative synergies. This may increase the rate and velocity of new biobased product developments, since innovation is rarely accomplished entirely in seclusion (Burns & Stalker, 1994). Overall, this action will help the entrepreneur do what he/she does well, that is to create new goods, new production methods, new markets and new forms of industrial organization (Schumpeter, 1950).

2.3.3 Network Ties. Studies have suggested that the “secret” of an entrepreneurial community or region is how regional development strategies and networks work together. Networks, which are often local and informal, are essential because they are links to potential sources of capital, new employees, strategic alliance partners, and services providers such as lawyers, accountants and consultants. These networks that will strengthen entrepreneurial growth are often private, and therefore, will not be fostered by traditional government and public sector approaches. These networks

may be more essential than one may first think, since entrepreneurs are consummate networkers who thrive in communities (Pages et al., 2001).

The model in Figure 2.3 exemplifies potential connecting linkages in the distributed business incubator network. The distributed business incubator hub is shown as the center for this analysis. The incubator then develops one-to-one relationships with various businesses and entrepreneurs, and regional stakeholders. For example, the incubator builds a relationship with the biodiesel venture management team, which ultimately results in a new venture development within the community.

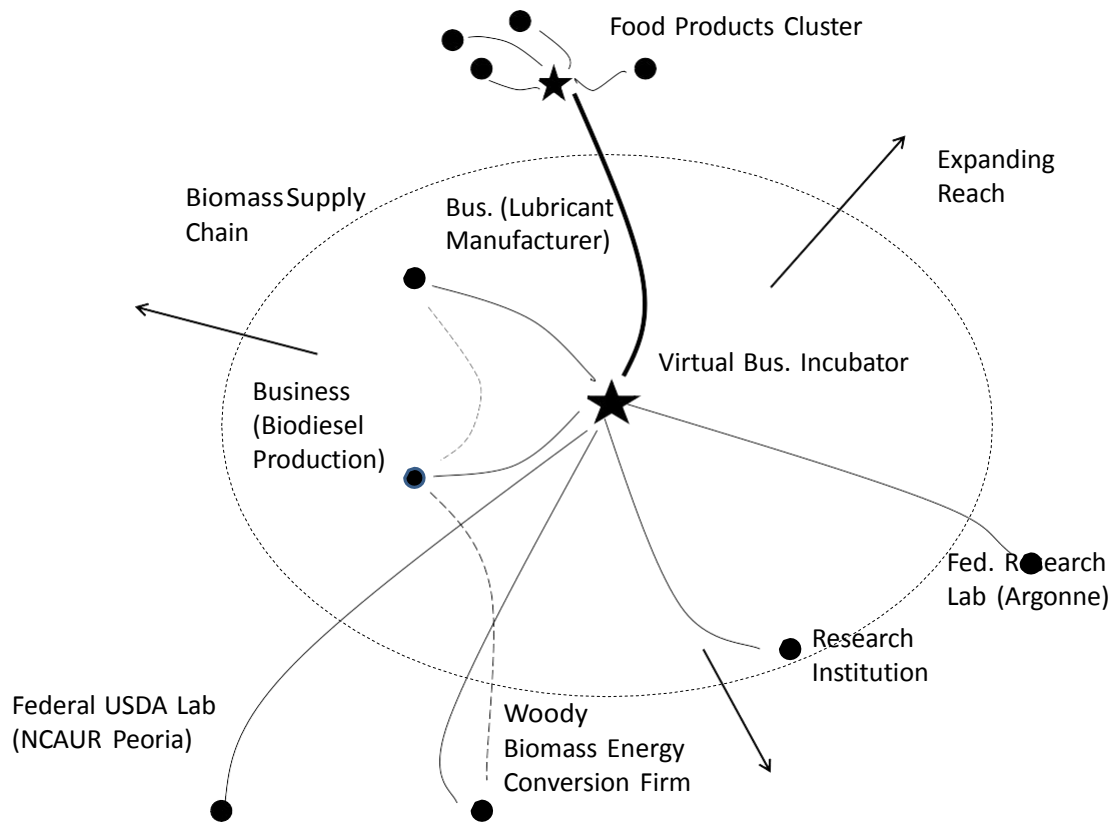

Figure 2.3: Distributed Business Incubator Model

The networked incubator also develops a business relationship with a prominent firm with lubricant product development and manufacturing competences; this firm is eager to seize emerging market opportunities in the biobased product sector. The incubator eventually introduces these two firms in order to explore potential supply chain synergies. One such opportunity is for the development of new lubricant products that will leverage the glycerol generated as a co-product in the production of biodiesel. As this type of activity continues, the incubation network gains momentum and the network reach will expand. The distributed incubator may also create trunk line connections to other strategic groups or clusters with which to explore synergies, such as a food products cluster less than an hour away.

In general, business incubators offer a range of shared services to entrepreneurs during the early stages of business venture development. Common services may include business coaching, shared office supplies/resources, and networked communications and information technology infrastructure. The business incubator environment can lead to introductions and new contacts for aspiring entrepreneurs. There may also be opportunities for entrepreneurs to meet more seasoned entrepreneurs and business leaders who may lend words of wisdom and experience.

One key contributing role of the networked incubator within the process of entrepreneurial economic development is a brokering role, with the incubator providing services to connect producers with users. Industrial biotechnology holds potential for significant impact on rural communities and regions, for consumer end users and for producers (Barkema, 2000). The business incubator may be a useful component within strategic regional efforts to increase the value of biomass resources, including biomass

co-products, and help entrepreneurs successfully launch new business ventures to commercialize these innovative products and systems. Business incubators have been used for years in varying efforts to spur new economic development, often in urban settings. The distributed model for business incubation may help extend the positive impacts of business incubator use more broadly and to an increasing number of rural settings. This development may also help leverage existing supply chain opportunities within these regions. Networked approaches help some key outcomes to be realized: more flexible business incubation capabilities, increased responsiveness to the market, attracting and engaging the best people while simultaneously reducing geographical barriers (Klobas and Jackson, 2008). Each of these outcomes will be a plus for rural regions. The effective use of distributed incubators and business networks holds strong potential to build the interconnections between researchers and businesses and to help more regions transition into regional innovation and entrepreneurship hotspots (Council on Competitiveness, 2004).

3. FRAMEWORK DEVELOPMENT AND METHODOLOGY

3.1. RURAL ECONOMIC DEVELOPMENT AND NEW VENTURES

This research develops “A Framework of Biobased Entrepreneurial Ventures for Rural Economic Development.” Rural economic development poses unique challenges and opportunities, based on a number of factors (Drabenstott, 2001). Additionally, certain entrepreneurial venture opportunities possess inherent attributes making them more viable for consideration in rural economic development (Walzer, 2007). Biomass supply chains are vital to biobased venture success (Fortenbery, 2005); therefore, initial emphasis will be placed on the potential biomass resource pool to be transformed through entrepreneurial productive activity into higher economic value products and outputs. Then, the value added opportunities will be explored and examined.

The literature contains examples of research pertaining to specific opportunities in rural economic development (e.g. ethanol, wind power). Many of these research efforts are limited in scope and often are highly contingent on economies of scale. Thus, there is an opportunity to develop and validate a framework specifically for rural economic development that is useful for a range of entrepreneurial ventures, focusing on biomass.

New ventures may consist of companies attracted from outside a region to develop new enterprises which promise economic activity in the way of employment growth and increased revenues/tax base for the area. Alternatively, ventures may originate from existing organizations and entrepreneurial individuals seeking to exploit new economic opportunities, which also stimulate new economic activity. However, for any new venture effort there are certain key factors to be defined and evaluated in order

to assess the new opportunity. For the scope of this research, biomass resources will be considered a starting point for developing value added uses.

3.1.1. Who, What, and How. Key factors in this research are classified into three distinct categories: economic resources, value adding transformative steps, and entrepreneurial stakeholders. Stated another way, these three distinct categories address the questions of “who,” “what,” and “how” as they pertain to the venture opportunity being analyzed. For example, *who* is involved, *what* resources are being strategically configured, and *how* are the resources being transformed (e.g. through new technologies). These three categories may be further classified and characterized for the specific analyses.

3.1.2. Analytical Approaches. Simulation and spreadsheet analysis methods facilitate evaluation which is useful to the strategic planning of biobased entrepreneurial ventures. This is important since the biobased sector is still a relatively new sector. Spreadsheet modeling and what-if scenario analysis methods leverage random sampling for evaluating system behavior; these methods help simulate a number of different factors and combinations much like the real world/actual practice.

This research integrates three case studies, each of which has been prepared for publication. Case 1 features a regional scale biodiesel operation, which utilizes a flexible feedstock process technology with used cooking oils as a primary input. Case 2 presents an algal biomass opportunity with the algae being harvested from a large regional wastewater treatment facility. Case 3 explores new use opportunities for a prominent food processor’s cucumber co-product fractions. These cases help illustrate a variety of variables, conditions and forces that may be relevant to and may act upon a new venture;

the cases are representative of a range of biobased entrepreneurial ventures that may be encountered in rural economic development.

3.1.3. Biomass Utilization. It is important to also keep in mind overall biomass utilization at a systems level. There has been increasing awareness and concern about non-food uses for agricultural products. The author certainly does not suggest the use of biomass products at a detrimental impact to individuals and groups in need of food. This thinking has been adopted by many experts and it has been largely integrated into this research.

For example, many of the suggested applications of biomass for entrepreneurial ventures are really looking at leveraging or re-purposing the leftover biomass fractions once the primary use has been made for food or feed applications. A general relationship may be expressed as shown in Figure 3.1.

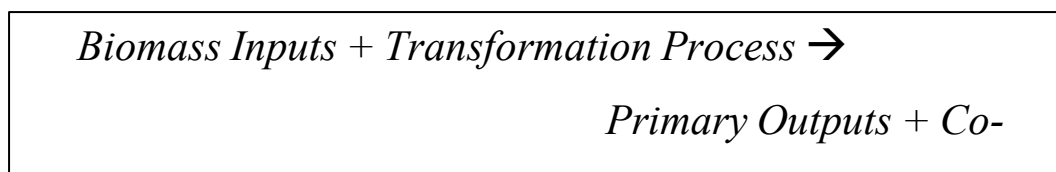

Figure 3.1: Biomass Inputs, Outputs, and Co-Products

Here, the inputs here are biomass crops or resources. The transformation process is some intermediary step or set of procedures (often requiring energy input) to convert the biomass into a higher value item or a new form in a process. It may involve a

physical operation such as cutting, chopping, or densification; it may also involve other changes including chemical and biological transformations. Then, the process results in the production of primary outputs which will likely be used for human food and/or added into value chains for animal feed, which typically correlate into increased production of food. The resultant co-products generated from this overall process are often the leftovers or residuals which generally are of relatively low economic value. These represent a sweet spot for the framework in this research as they hold significant opportunity for value addition given a suitable combination of technological and market feasibility. This general relationship forms a basis for the framework in Figure 3.2.

3.2. FRAMEWORK FOR BIOMASS-BASED ENTREPRENEURIAL VENTURES

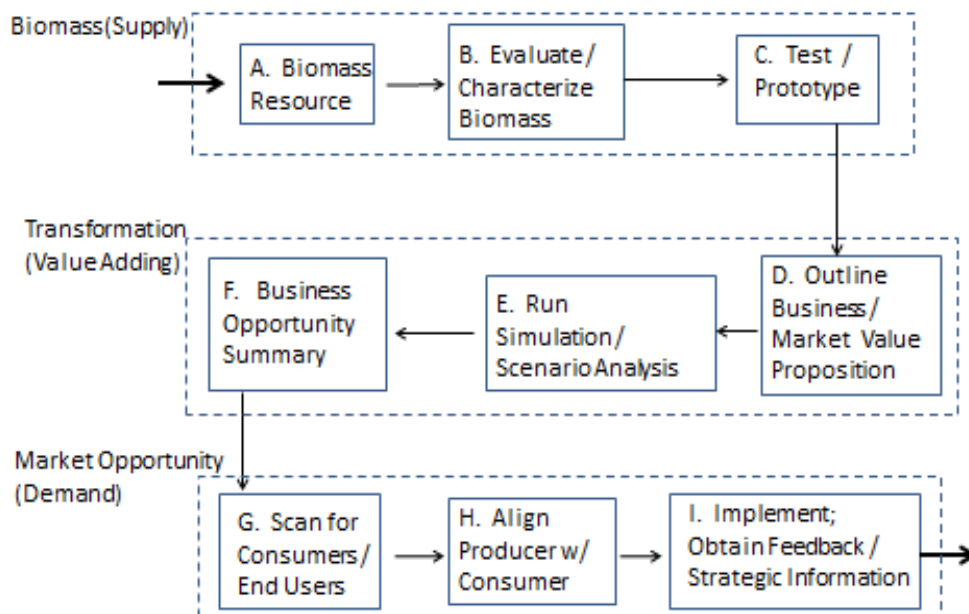

Figure 3.2: Framework of Biobased Ventures for Rural Economic Development

Supply Base and Technical Feasibility (A-C)

- A. Biomass Resource: supply of biomass that is/can be made available at low (or negative) cost
- B. Evaluate/Characterize Biomass resource: search for/conduct necessary evaluation to identify characteristics such as specific energy, nutritional composition, biological structure (fibrous, etc.) and other unique attributes
- C. Testing/Prototyping: create a prototype/laboratory procedure/proof-of-concept if possible to verify technical feasibility of this opportunity/innovation (may include the integration of technology in a new way)

Business/Economic Feasibility (D-F)

- D. Outline Business/Marketplace Value Proposition: quantifying potential market interest/demand for products/services, price points, distribution factors
- E. Run Simulation/Scenario Analysis: factors will include feedstock variation, market conditions, commodity dynamics, current & anticipated consumer/industry demand
- F. Develop Business Opportunity Summary: go to market options, strategic configurations, sell/license

Market Opportunity Identification/Alignment (G-I)

- G. Scan for Consumers/End Users: search and identification of potential consumers of this biomass resource; may be an end user or an intermediary who will perform additional transformation into value added state
- H. Align Producer of Biomass with Consumer: making an introduction or “setting the table” to create opportunity/ conditions for an economic transaction to occur
- I. Implement & Obtain Feedback: implementation stage and subsequent follow-up to gain useful information to plow back into organization

Some scholars have indicated that technology oriented entrepreneurship (Shane, 2005), which in this case is concentrated in rural geographical areas, adds uncertainty and challenge to the establishment of a new venture or an entrepreneurial effort within an existing organization. The use of simulation and Monte Carlo methods in this research

allows the investigator to randomly simulate a range of scenarios that may be encountered by a new startup venture. This process provides rich input in the strategic planning process, helps identify risk factors, and highlights conditions for which contingency planning may be prudent. Although it is not possible to eliminate risk completely, the framework developed here will aid in the process of more effectively managing risks inherent in biobased entrepreneurial ventures in rural economic development, as well as assessing entrepreneurial opportunities presented in new biobased ventures.

A decision diagram in Figure 3.3 illustrates the overall thought process in evaluating strategic new use options for biomass. The left hand side shows biomass as the key input while the right hand side shows alternatives for outputs or products to be derived from the biomass. The alternatives on the right illustrate major categories of opportunities for biomass applications. These categories are as follows: food, feed, fiber, fuel, fertilizer, and other.

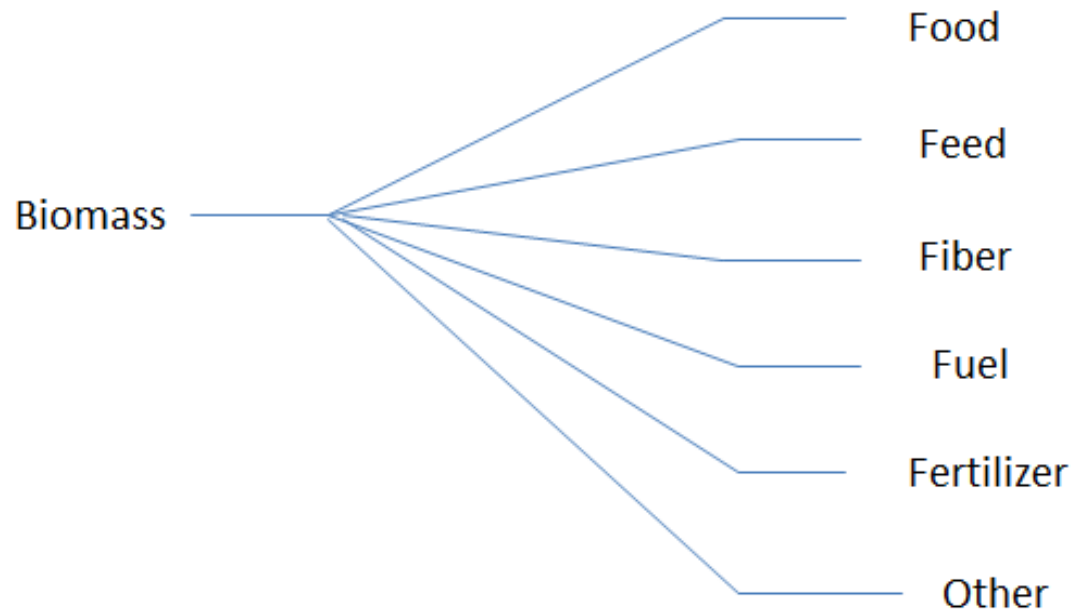

Figure 3.3: Strategic Output Alternatives for Biomass

In many cases, the biomass input is a co-product of another production process. Typically, the primary use for purpose grown crops is geared toward human food value chains; this will include crops like field corn which are raised initially to provide feed for cattle which will ultimately be an input in human food chains. The idea of co-product utilization is important here. For example, soybeans produce not only the meal fraction but also a soy oil co-product. Alcohol fuel production from corn utilizes the starch fraction to produce alcohol while the remaining fiber, protein and oil co-products are useable for livestock feed applications.

4. THREE CASES FOR THIS RESEARCH

This research employs a case study approach. It focuses on three separate studies, each related to innovative opportunities with biomass. The first case focuses on a regional approach to biodiesel. The second case examines algae biomass as a means to help filter water at a wastewater treatment plant, and then to be able to offer value-added use as an energy supplement. The third case relates to a food processor's production waste and how that form of biomass can be repurposed into higher value applications. The framework, which is central to this research, will be used throughout.

4.1. CASE 1: REGIONAL BIODIESEL

Biodiesel can be used in conventional diesel engines with virtually no engine modifications. As a fuel, biodiesel tends to burn cleaner both in terms of decreased residuals left in the engine as well as lowered emissions released into the atmosphere. Biodiesel production also generates glycerin as a valuable secondary product. There are numerous industrial and commercial uses for glycerin, including for a blending ingredient in soaps and cosmetics.

Biodiesel can be made from the oil of various oil producing crops like soybeans, palm oil, sunflower oil, camelina, pennycress, and Jatropha. Other sources of oil are waste vegetable oils from cooking processes at restaurants. Even more innovative oil sources are being researched for future production of biodiesel, including algae.

There is currently much press coverage, public awareness and publications about biodiesel. This is likely due to a combination of factors including America's vulnerability to foreign oil pricing and supply, environment concerns and the potential to increase renewable energy adoption. Some of the key stakeholder organizations include the National Biodiesel Board, the Renewable Fuels Association, and the Illinois Soybean Association. Other sources include key research universities with experts studying biodiesel.

The overall feasibility and economic viability of a strongly growing biodiesel industry is highly dependent on the availability of a steady, constant supply of vegetable oil inputs. Earlier works focused primarily on the supply of soybeans capable of being produced and replenished annually, since the soy oil is essential for biodiesel production, and the other oil sources are currently available only in fractional quantities with respect to soy oil. These efforts were also typically larger scale ventures as opposed to regionally sized projects. More recently, used cooking oils and other sources of vegetable oils have been recognized as viable inputs for biodiesel production.

Case 1 features a regional scale biodiesel operation, which utilizes a flexible feedstock process technology with used cooking oils as a primary input. Alternative vegetable oil inputs, especially those that are a secondary use and do not reduce food supply chain resources, hold promise for future competitive advantage and supply chain strengths. These feedstocks may also be sourced in a relatively smaller regional footprint. The biodiesel plant was designed to produce 5 million gallons of B100 biodiesel product annually, and would be described as a sustainable economic development project (Rangarajan et al., 2012) for longer term planning. The framework

shown in Figure 4.1 illustrates the three key areas of evaluation for strategic planning of a new biodiesel venture. The supply chain area will be necessary to provide feedstock to the plant. The supply should be at a reasonable or below market cost, should be sufficient to address the needs of the production facility, and should be stable over time and not vulnerable to swings in commodity markets. The conversion processes in the transformation stages of the framework should be proven, cost effective, and preferably should offer some technological innovation that differentiates this operation from others already in operation. The market opportunity realm should have established channels to move product into markets; this may be further enhanced by niche product market opportunities.

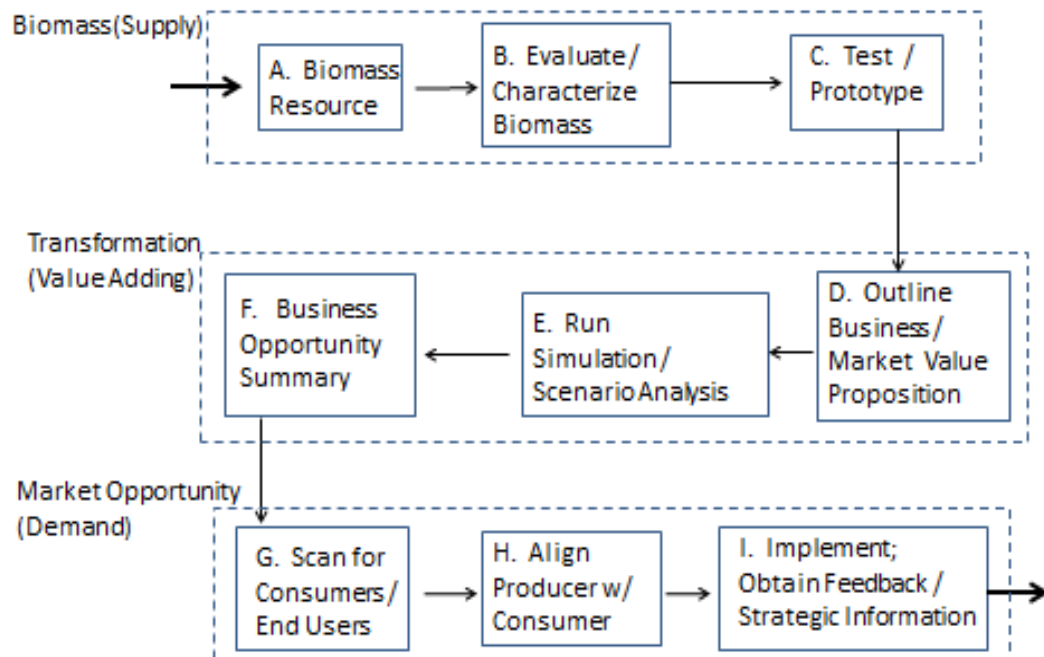

Figure 4.1: Framework of Biobased Entrepreneurial Ventures for Biodiesel

At the time of development this was a modestly sized plant, since many other biodiesel ventures were being planned for much larger operation. While the larger plants may enjoy economies of scale, at some point the production volume and size of operation exceeds an equilibrium point (shown as Q2 in Figure 4.2). Increases in quantity along the horizontal axis beyond this equilibrium point result in diseconomies of scale and increased long range average costs. Note that the point at which this shift in the U-shaped curve occurs will vary by characteristics specific to the industry and supply chain being studied.

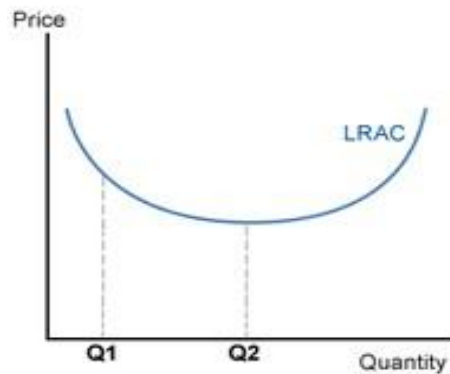

Figure 4.2: Cost Curve

As Jacobs and Chase (2008) assert, one major factor contributing to diseconomies of scale may be the cost to transport raw materials to the plant and finished product from the plant. For example, ready-mix concrete is a more regionalized production process, for very practical reasons. Other examples may include gravel pits, recycling centers and landfills.

The primary output or product to be sold is biodiesel fuel. Biodiesel also has other applications primarily through its solvent capabilities, although these have only been deployed minimally into markets. The primary product is a 99.9% concentration of biodiesel fuel, to be blended in with petroleum based diesel in various concentrations to result in on- and off-road liquid fuel blends. Biodiesel offers a number of potential environmental benefits including reduced particulate pollution and less sulfur. This dovetails well with the transportation sector's reduction of allowable diesel fuel sulfur. Biodiesel has inherently higher lubricity than petroleum diesel, compensating for the lubricity enhancement of sulfur in petroleum-based diesel. (Mirza et al., 2010). The biodiesel production process additionally results in the output of a co-product, namely glycerin (or glycerol).

Biodiesel can be manufactured from a range of biorenewable feedstocks. Current key feedstocks from which biodiesel is produced include soybean oil, canola oil, tallow/animal fat, trap grease, corn oil (e.g., sourced from ethanol plants), and reclaimed vegetable oil. The chemical name for biodiesel is fatty acid methyl ester (FAME). Pure biodiesel is referred to as B100 while one common blend is designated as B20, which is 20% biofuel. This study is evaluating all the commercially-available blends: B5, B10, B20, B50, and B100. (Mirza et al., 2010)

This case examines a modestly sized biodiesel operation that is scaled to operate within a regional footprint. Therefore, logistics is one of the factors considered, and the effective distance in miles is sought to be reduced. The production facility obtains its inputs from regional suppliers with a typical radius of 70 to 120 miles. The biodiesel operation also strives to sell and distribute its product within a similar regional radius.

This differs from the operational model of large scale fuel production facilities which frequently move inputs and outputs over great distances, often crossing several states to reach destination points and adding crucial costs to the finished product. A range of input options are considered for this case.

An initial screening matrix in Table 4.1 is used as a decision tool to categorize supply chain opportunities related to a regional approach to biodiesel. The categories include: food, feed, fiber, fuel, fertilizer and other applications. While this matrix is not deterministic and not exhaustive, it is useful for classification and identifying what is a likely use (Yes), unlikely (No) and which alternatives may hold potential for the future but may require additional research.

Table 4.1 Strategic Outcome Options, Alternate Oil Based Biodiesel Supply Chain

Primary Use	Application	Additional Considerations
Food	Cooking oil for consumers	Meal fraction to livestock
Food	Cooking oil for restaurants	Meal fraction to livestock; Collect, filter and process used cooking oil into biodiesel

To begin, an overview of biodiesel production and the market sector is provided. Biodiesel is a versatile liquid fuel since it may be derived from a range of inputs and can be utilized in a range of diesel engines without significant efforts or required modifications. The biodiesel industry has experienced dynamic growth trends over the

past several years, resulting in expanded market reach and penetration. Many major fleets have begun adopting biodiesel blends into their fleet stocks, including the US Postal Service, the United States military, as well as numerous state and local governments. In 1999, there were less than 1 million gallons of biodiesel produced, and by 2005 approximately 200 million gallons were produced. The demand for biodiesel – including the use of it as a lubricity enhancer to reduce undesirable sulfur- sent market signals to producers for biodiesel supply. Biodiesel is also impacted by other market factors; in addition to the impressive growth movements, there have also been periods in which production declined, as displayed in the figure. The Department of Energy is one source of descriptive data to aid in the analysis; USDA and National Biodiesel Board are additional sources.

An alternate source of vegetable based oil as an input is essential to creating strategic options in biodiesel. The establishment of new and alternative cropping systems may be one tool to help expand a more local and regional supply base of vegetable oil inputs for the biodiesel venture. One such crop is canola; this is not a new crop but rather one that is more common in Europe, Canada, and in our Plains states. This is a dual crop which may be locally grown and even processed in some cases. A 26 acre demonstration plot was recently harvested in Boone County, IL (see figure in Appendix). For smaller scale volumes, a local processing facility may mechanically extrude or expel the oil from the harvested canola seed. Roughly one-half of the seed is oil-containing, so that fraction generates canola oil and the remaining portion goes into meal which may feed livestock. The canola oil is preferably used for food applications first of all. For example, it may be used for cooking in restaurants. Then, when the oil has been sufficiently used for

cooking, it may be collected, filtered, and transported to the biodiesel plant where it will be converted into biorenewable fuel product. There may also be some inherent benefits to biodiesel produced from canola oil including cold weather properties, which are important for fuel product applications. The establishment of a regional canola supply chain may be attractive for rural economic development for a number of reasons: new crop rotation options for producers, health benefits of naturally processed vegetable oils, and employment opportunities for the region.

The business case for biodiesel was modeled using the Monte Carlo simulation methods. This analysis is applicable as there is significant uncertainty for the given inputs. Here, the domain of possible or likely inputs is defined and then the model inputs are generated randomly from a probably distribution of that domain. The results are then computed and reported. For this research, the Frontline Solvers Risk Solver Pro V12.0 (Frontline, 2012) application was used within Microsoft Excel.

This image in Figure 4.3 shows a snapshot of the Monte Carlo simulation results for biodiesel produced using conventionally sourced used vegetable oil inputs available on the existing markets. The illustration is on the simulation run for sales scenario Number 3, which indicates for slower market conditions and less robust selling price.

Sales Scenario 3, Commodity Input Costs						
Market Condition		Volume	Price			
Strong Market	1	5,000,000	\$ 4.50		Analysis	
Stable Market	2	4,000,000	\$ 4.40		Sales scenario	3
Slow Market	3	3,500,000	\$ 4.30		Sales Volum	3,500,000
					Selling Price	\$ 4.30
Production Costs					Unit Cost	\$ 2.20
		(inputs including vegetable oil)				
Low	\$ 2.00					
Moderate	\$ 2.50				Net Profit	\$ 865,670
High	\$ 2.75				Average Profit	\$ 91,626
Fixed Costs	\$ 6,500,000					

Figure 4.3: Base Case of Biodiesel Venture Simulation

The image in Figure 4.4 illustrates a snapshot of the results of Monte Carlo simulation for biodiesel production using a lower cost vegetable oil input. This vegetable oil input may be sourced locally through an established supply chain that includes local crop production and harvesting, with an initial use as a food product in restaurants. Once the product has been used in the food production application in restaurants, the used cooking oil can be reclaimed, filtered, and sold to the biofuels operation for feedstock in biodiesel production.

Sales Scenario 3, Improved Production Input Costs					
Market Condition		Volume	Price		
Strong Market	1	5,000,000	\$ 4.50	Analysis	
Stable Market	2	4,000,000	\$ 4.40	Sales scenario	3
Slow Market	3	3,500,000	\$ 4.30	Sales Volum	3,500,000
				Selling Price	\$ 4.30
Production Costs				Unit Cost	\$ 1.88
(inputs including vegetable oil)					
Low	\$	1.50			
Moderate	\$	2.25		Net Profit	\$ 1,955,587
High	\$	2.50		Average Profit	\$ 1,258,371
Fixed Costs	\$	6,500,000			

Figure 4.4: Biodiesel Venture Simulation with Lower Cost Feedstock

As shown, this scenario indicates much improved profitability over the example run for conventionally priced oil inputs. This illustrates the sensitivity of the biodiesel operation to input price, and underscores why a biodiesel venture would be well advised to strategically align itself for long term supply contracts, for example through alliances with agricultural producers as well as other vegetable oil sources like food processors.

4.1.1. Impact Analysis for Economic Development. An IMPLAN (Impact analysis for PLANning) analysis has helped quantify the operational impacts of a biodiesel plant of this size within the state of Illinois. IMPLAN methodology makes use of input-output models; in general, such models are useful for economic development in that they help quantify interactions between industrial sectors within an economy (Mulkey and Hodges, 2009). The model estimated the creation of 21 direct employment positions and 53 indirect positions; the annual impact is \$1.3 million and \$2.7 million,

respectively, for a total of \$4.0 million annually through employment. The results reported that the biodiesel fuel production facility will increase the value added (wealth) of the state by over \$10.5 million (NIU Regional Development Institute, 2009). These are important to the economic development of a rural region, both in terms of direct production activities as well as in the overall ripple effect of business activity and interaction with suppliers and service providers nearby. The biodiesel industrial sector saw significant growth trends beginning in 2005 (Figure 4.5).

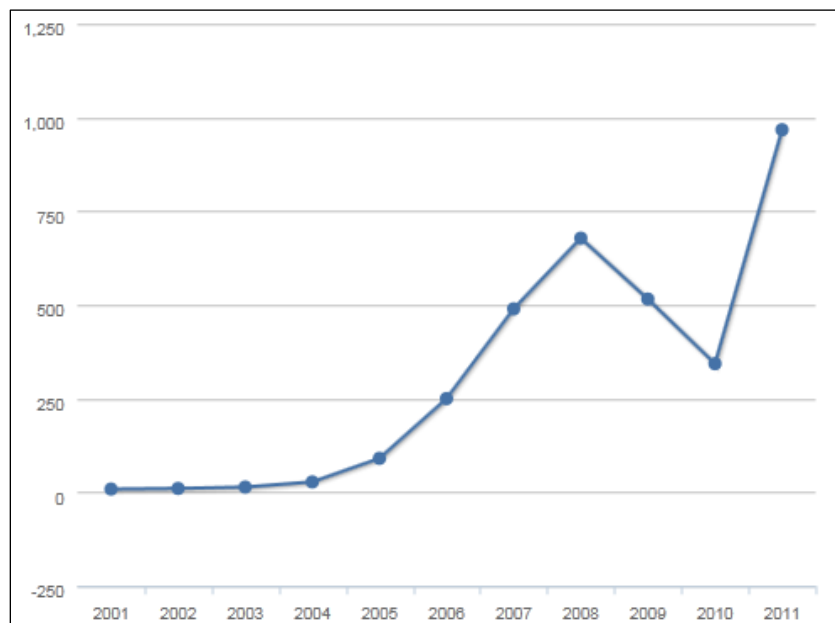

Figure 4.5: Annual U.S. Biodiesel Production, Millions of Gallons (EERE, 2012)

4.1.2. Biodiesel Co-Product Opportunities: Glycerol. Historically, the ethanol sector of the biofuels industry –as a counterpart to biodiesel- experienced significant demand growth earlier than biodiesel, so one may say that the ethanol industry is a little

“further down the road” in terms of market establishment and product maturity. Ethanol production also generates a significant co-product which is referred to as “Distillers Dried Grains with Solubles” or DDGS, for short. The DDGS co-product includes the fiber, protein and sometimes oil portions which are not used in the starch-to-ethanol fermentation process. Earlier in the ethanol industry’s growth, there was a surplus of DDGS and the market value of this “corn meal” product was relatively low. Local farmers would purchase a higher moisture form of distillers grains for feeding their livestock, but this wet product had a relatively short “shelf life” and the inherent moisture content made it unfeasible for shipping longer distances. Since then, the ability to containerize and ship the dried product to emerging markets globally has resulted in a significant upswing in the market value of DDGS. This has also benefitted the overall economic equation for production of corn-based ethanol through additional consistent revenues from co-product sales.

The process for producing biodiesel from oilseed inputs involves chemical reactions that result in the biodiesel product. A co-product that is also generated in the production process is glycerin, or glycerol. In a manner similar to the Distillers’ Dried Grains with Solubles generated in the production of ethanol, the production of glycerin as a biodiesel co-product represents opportunities for innovation in developing value adding, new use opportunities. Estimated crude glycerin generation for a 60 M gallon/year biodiesel plant is ~ 24,000 tons/year. It is apparent how the realization of value in biobased co-products (namely distiller grains) has positively impacted corn ethanol; it would then follow that the ability to derive higher economic value through

new use applications for unrefined (or even partially refined) glycerol would similarly benefit the biodiesel sector.

Glycerol (glycerin) is a co-product of the transesterification reaction used to produce biodiesel from an oilseed input or feedstock. Although there are other reactions/processes by which biodiesel may be produced, transesterification is the most commonly used commercial process. The glycerol co-product of this reaction is in an unrefined or “crude” state. Glycerol in and of itself is not innovative or a new chemical per se; however, the growth of the biofuels industry and specifically the biodiesel sector has ushered a large amount of this crude glycerol into the marketplace. Most current applications for glycerol are for the highly refined or even pharmaceutical grade of glycerol. This includes a vast array of product applications such as cosmetics and refined chemicals. The achievement of this highly refined state does not come inexpensively, however; without sufficient economies of scale and locked-in long term supply contracts, it is difficult to justify refining of glycerol to a high level of purity.

Since glycerol is such a ubiquitous substance with a range of desirable properties, it lends itself to a host of applications. At this point, it seems prudent to maintain focus on the “low hanging fruit” opportunities, which may not promise the highest rate of return; however, these types of opportunities carry relatively lower associated project risk and typically do not require significant capital outlays. Unrefined glycerol may be used as a source of thermal energy as it may be combusted in industrial burners and shop heaters. It may also be blended with other biomass feedstocks to be fed into gasification systems (e.g. to displace/reduce coal fractions at utility plants, assist in drying grain, provide energy supplementation at biofuels facilities). Glycerol has also been shown to

be a beneficial additive in anaerobic digesters to effectively provide more food for microbial activity and to increase gas production for combined heat and power generation. Glycerol may also be used as a platform chemical in other industrial applications (e.g. lubricant additives, plastics compounding and more). Given the approximate energy content of 7,000 Btu/lb to 9000 Btu/lb, the energy uses of glycerol appear at this point to represent the more readily achievable opportunities.

An IMPLAN analysis was run (NIU Regional Development Institute, 2008) to examine the economic impact of re-purposing unrefined glycerol as an energy feedstock. The estimated employment impact was 5 direct positions and 23 indirect positions. This represented approximately \$0.5 Million in employee compensation for the direct and over \$1 Million for the indirect. This opportunity will also produce sales and will result in state and local taxed over \$300,000. This helps to characterize one of the potential value added opportunities for the glycerol co-product of biodiesel production.

4.1.3. Direct Use Opportunities: Thermal Energy. Many production and manufacturing operations require heat for the shop floor space. These systems are often designed for natural gas use, where available. Some shop spaces may utilize reclaimed energy stocks such as engine oil and other recycle inputs. Recent trends have led to new product and system developments, such as burners designed with flexibility to accept a range of inputs including a blend of glycerol with other inputs like petroleum based oils or vegetable oils (A.7 in Appendix). This type of new use application for glycerol is a low hanging fruit opportunity; there is not a need for high capital investments in order to utilize the glycerol.

4.1.4. Direct Use Opportunities: Dust Control. Townships and rural road commissions often struggle to limit dust on gravel roads (A.9 in Appendix). They will often spray with aqueous mixtures in order to suppress the dust. A glycerol-water mix has been found to work well. This can be utilized in a relatively local footprint to minimize distribution costs. It can also reduce costs for substitute materials such as calcium chloride and can be applied with existing equipment.

4.2. CASE 2: ALGAL BIOMASS FROM WASTEWATER TREATMENT

Case 2 presents an algal biomass opportunity with the algae being harvested from a large regional wastewater treatment facility. This is a publicly owned treatment works (POTW), of which there are approximately 21,000 in the United States of America (University of Michigan, 2011). This research effort combines key elements in that it considers both environmental aspects of wastewater treatment as well as energy considerations at an operational level; as Long and Cudney (2012) illustrate, these two factors are not often jointly considered in efforts examining municipal treatment of water. Note these systems are gross consumers of input energy, accounting for one-third to one-half of municipal energy use; on a national level, wastewater treatment systems account for nearly 3% of electricity consumption in the U.S. (Long and Cudney, 2012).

The type of project represented in this is an example of a public sector engineering economy problem (Eschenbach, 2003). As Eschenbach states, there are “benefits and disbenefits” which are consequences to the public at large. Eschenbach explains that there are a number of reasons that public sector projects may be more

difficult than private sector projects. In public sector projects, the benefits may be more difficult to quantify and to value in financial terms. These projects also carry a much longer term horizon and involve varying stakeholder interests.

The framework show in Figure 4.6 addresses the three cores areas strategic planning of algae biomass at a water reclamation district. The supply chain includes the nutrients already present in the water and the biomass which grows in the water and feeds on these nutrients. The transformation realm consists of infrastructure, hardware, and technical knowledge to proactively grow algae to reduce the concentration of nitrogen and phosphorous in waste water; additionally, the hardware will remove the cultured algae from the water. The market opportunity realm focuses on the value creation and in this case will primarily be focused on energy production.

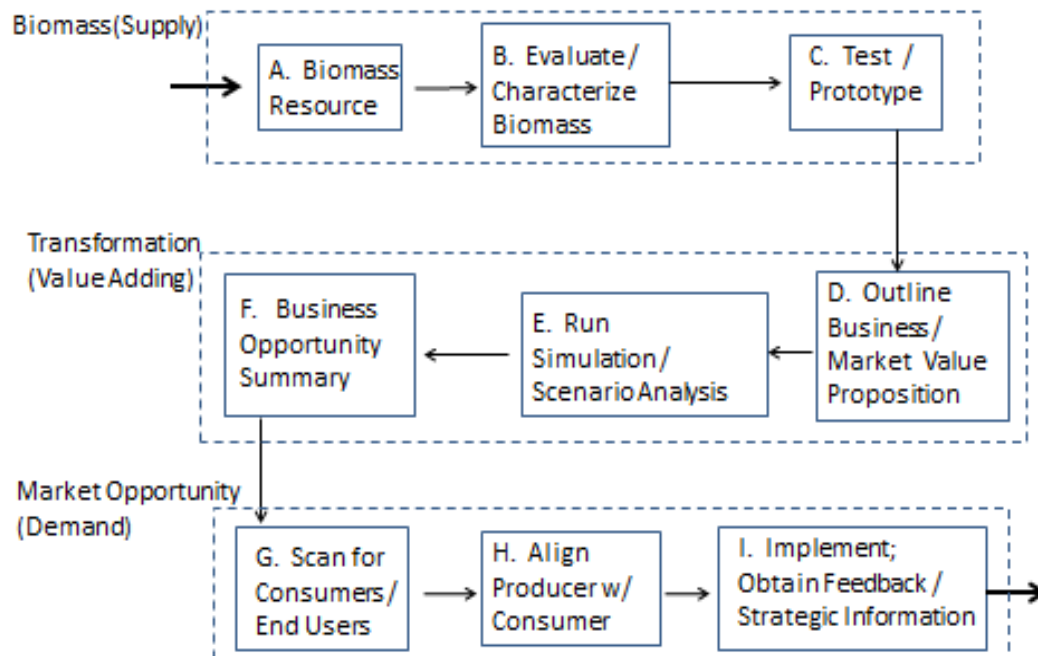

Figure 4.6: Framework for Algal Biomass at Water Treatment Plant

Algae have been receiving much attention lately in the literature in terms of potential for biofuels, biobased products opportunities, and a wide range of other opportunities ranging from plastics to nutritional supplements to cosmetics. Much of this attention has been on the microalgae which typically are more suited to growth in a closed system and which carry a relatively high proportional content of lipids for oil input into biodiesel. While the oil yields of these microalgae can be relatively high, these algae can be more difficult to culture and to sustain. This case takes on a different perspective; this case explores the use of the filamentous macroalgae that naturally at water treatment facilities to improve the quality of the water being discharged from the operations. The algal biomass here will serve three functions. First and foremost, the algae will greatly enhance nutrient uptake of nitrogen and phosphorous, which is required for POTW's. Secondly, the growth of algae will result in a co-product left over after it has performed the work of nutrient uptake. The biomass co-product will be available for new uses such as conversion to energy or fertilizer. Third, the adoption of such a system will generate increased economic activity within a region, the impacts of which will include job activity. So, the impacts of an integrated algal biomass system at a POTW may include environmental, energy and economic development benefits.

Algal biomass occurs naturally at water treatment facilities (Figure 4.7), and is typically considered a nuisance growth form. The algae growing in these conditions actually take nutrients from the water in the form of nitrogen and phosphorus. Nitrogen and phosphorus also happen to be nutrients that are being more stringently regulated and monitored by state and federal environmental agencies; these impending regulations will

likely require significant infrastructure investments to improve the capabilities of water treatment operations to further remove these nutrients.

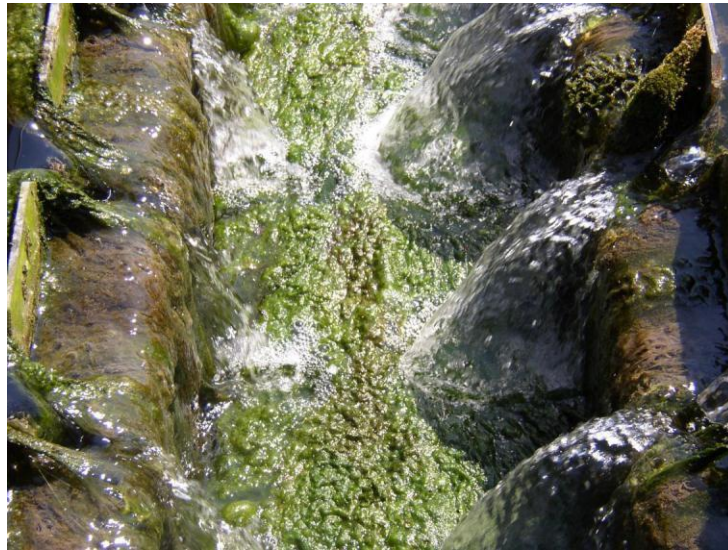

Figure 4.7: Algae Occurring Naturally within Raceways at Water Facility

A logical approach, then, is to consider proactively growing specific strains of algae which thrive under the conditions inherent at a water treatment operation. The lipid fractions of algal biomass may be useful as biodiesel inputs and the remaining biomass fractions will remain for additional value added utilization. This biomass growth presents a unique opportunity without impacting food chains and it offers operational benefits for water treatment operations. A screening matrix is shown in Table 4.2, to outline key opportunities related to algal biomass at a water district.

Table 4.2 Strategic Outcome Options for Canola Based Biodiesel Supply Chain

Primary Use	Application	Additional Considerations
Feed	Livestock	Evaluation by test lab necessary
Fiber	Biobased materials	Filamentous fractions/strands for material applications
Fuel	Anaerobic Digestion	Cellulosic conversion applications
Fertilizer	Field and nursery	May be processed into fertilizer pellets

Researchers and practitioners have indicated that about three-fourths of biodiesel cost is attributable to the sourcing of the lipid/oil feedstock. This currently represents an economic barrier for growth of biodiesel sector. At the same time, there remains competition for land resources and edible uses for vegetable oils. There are two distinct realms of algae, namely microalgae and macroalgae. The microalgae have been the subject of most of the recently published research on algae for biofuels. While these algae typically have a larger lipid fraction, there remains much to be learned about how to culture them economically.

This case begins with harvesting of algal biomass from a large wastewater treatment facility in the region. The algae are harvested with screen material and rakes. Then, the biomass is placed on trays for initial moisture reduction under ambient conditions (Figure 4.8).



Figure 4.8: Filamentous Algae Harvested at Water Facility; Initial Moisture Reduction

For the initial trials, the filamentous algae yield from the selected harvesting surfaces of the water district during the month of June (2011) showed the rate of production in wastewater to be 8.5 kg/m^2 . This translates to approximately 0.85 kg of dry weight in a period of four weeks.

The algae that have been collected are compressed to reduce moisture and then are placed outdoors on frames with screen material. They are allowed to dry until their

moisture content is approximately 10% by weight. For the purposes of laboratory characterization, some algae have been further dried to reduce degradation action by fungi. Then, the algae are examined in the laboratory with instrumentation. Analysis has indicated oil concentrations of between 3% and 6% by weight. These oil fractions (Figure 4.9) are instrumental if biodiesel fuel is to be produced from the algal biomass.

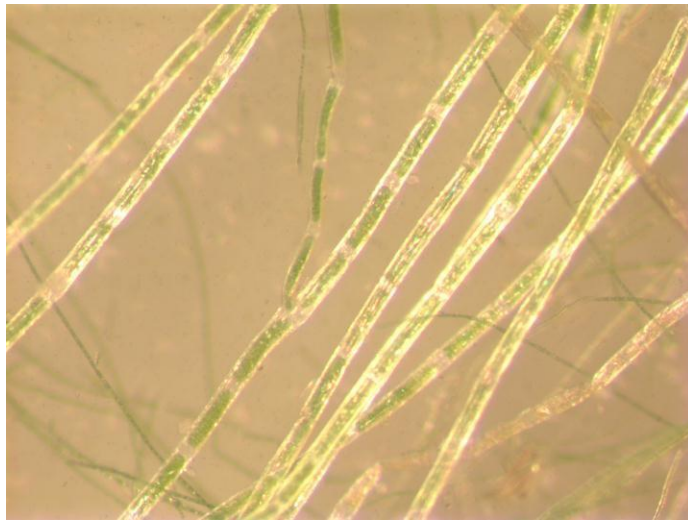

Figure 4.9: Lipid Concentration under Microscope

A community-scale biodiesel simulation used the data obtained on the filamentous algae. This effort was conducted in collaboration with colleagues from Iowa State University. The harvesting, drying, and oil production steps have been modeled using large-scale commercial tanks and stations. Both mass balances and economic calculations are calculated in the modeling process, to help minimize the presence of logical errors in the model prior to running the simulation.

Analysis of key parameters illustrated the impact of oil yield on this approach to algal biodiesel production. It is reasonable to assume extended research and development will lead to higher lipid yields per unit mass of algal biomass harvested from a water reclamation operation. The yield increase may be attributable to improved extraction methods, adoption of macroalgae strains with higher inherent oil composition, or both of these improvements.

SuperPro Designer[®] by Intelligen, a robust application, was chosen for process simulation. The ability to perform such simulation is valuable in terms of potential process improvement, cycle time reduction and cost analysis. This software package has flexibility and can be used for process optimization for biochemical, food, agricultural, wastewater operations and more. It can evaluate numerous variables like manpower, energy requirements, capital equipment expenditures, variable costs, and more.

The simulation modeling efforts begin with a simplified process flow diagram (Figure 4.10). This incorporates key assumptions and serves to build a model that is representative as a tool for evaluating options while at the same time avoiding a high level of complexity which would make the system difficult to use and the results hard to interpret. There are inputs for establishment costs such as capital equipment. The application also includes operational factors like utility costs and workforce labor requirements. Also, sensitivity analysis can be readily performed to vary key inputs such as the lipid profile of the algal biomass, and then the resulting outputs may be evaluated. The systems modeling helps examine the culturing, harvesting and processing of algal biomass at the water reclamation district.

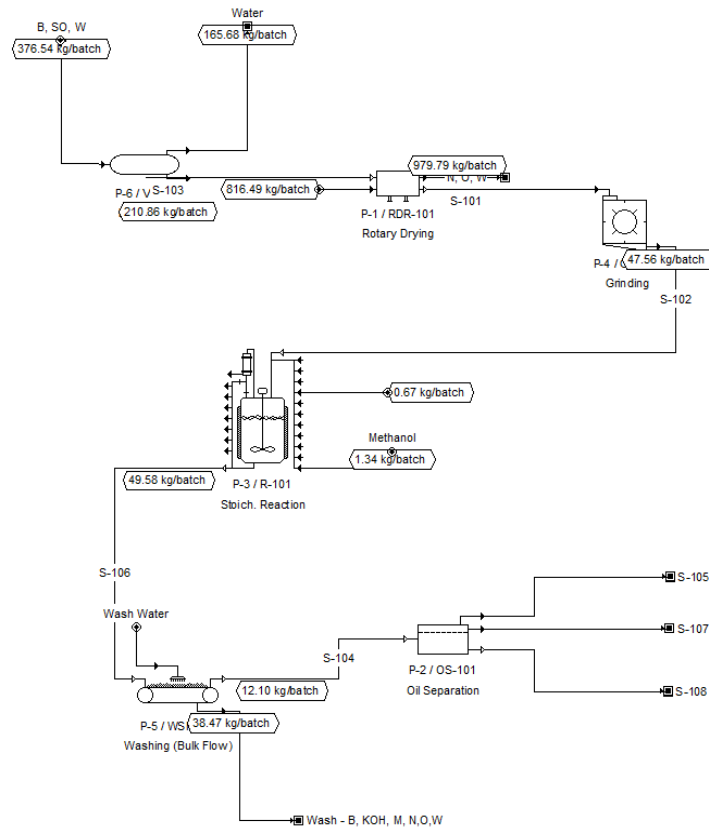

No.	Title	Stage
P-2	Flow Splitting	Drying; moisture reduction
P-3	Grinding	Hammer Mill
P-5	Mixer-Settler Extraction	Separate Oil from Biomass
P-1	Stoichiometric Reaction	Transesterification; Produce Biodiesel
P-6	Oil Separation	Phase Separation; Biodiesel Product

Figure 4.10: SuperPro Process Diagram

A simplified process flow model was created to simulate the production operation for creating biofuel from algal lipids. This was developed for research purposes and includes certain assumptions to facilitate the simulation process. One of the key limitations found in this investigation was the oil or lipid concentration of the particular

strain of algae native to this area and this water treatment facility. Laboratory results of analysis conducted by colleagues at Iowa State University indicated a lipid concentration of only 2.9%. For reference purposes, it is not uncommon to read of microalgal species that carries 10-15 times that lipid proportion, although those species have shortcomings and are not likely to grow robustly in the conditions of the facility in this research.

A number of factors align in favor of the opportunity to utilize algal biomass at wastewater treatment facilities. First, algae naturally occur at water treatment facilities. Second, algae can perform work in a wastewater treatment system. Third, the residual algae remaining as a co-product of the water treatment process may be used in a value added form after it has helped perform such work.

The first point that algae naturally occur may seem obvious. However, this is not trivial because it is important to note that only certain algal biomass forms are hearty enough to resist predator activity as well as weather dynamics. Phycologists and biologists focusing on algal forms have deep levels of expertise on characteristics of the thousands of species of algae.

The second point above is a key point in that it indicates the potential for economic value of algae within a wastewater treatment system; this is quite a contrast to the conventional perspective of algae as a problem or nuisance growth form. This is an essential observation and really represents the opportunity identification or “aha” stage for this in terms of entrepreneurial and economic development potential.

The algae will be harvested and removed from the system once it has performed the work indicated in the second point above. The remaining algae product is then available for new use applications which may vary widely. One practical application at a

local wastewater treatment facility is for the production of methane to power the engine generators to make electrical power and thermal energy. This facility has a cogeneration facility onsite and produces enough electrical power to satisfy the plant's operational requirements; often, the cogeneration plant is able to produce excess electrical power and then the wastewater treatment facility is able to route this power back through switchgear it owns and into the grid for additional income. Algae can be added to the bath in the anaerobic digester to proliferate increased methane gas production. Another application is that the algal biomass may be considered for feedstock into a gasification system; such a system can produce energy and will also have an added co-product named biochar. The Biochar can be a value-added component to add to soil to increase soil characteristics. Although the biochar in and of itself does not add nutrients to the soil, it does have certain benefits that may be useful to agricultural producers, gardeners and greenhouses. The addition of biochar creates conditions to encourage beneficial microbial activity. Other new use alternatives include fertilizer, plastics and biofuels such as cellulosic ethanol or biodiesel.

Another factor relates to projected requirements for tighter regulations. Environmental protection agencies, including federal and state organizations, have been focusing on tighter regulations on the composition of the outgoing water discharged from wastewater treatment facilities. Key factors being measured and monitored include nitrogen levels and phosphorous levels; the allowable levels are being reduced over time. The processing facility modifications and upgrades needed to achieve the projected new performance standards will not be trivial. Major capital investments will be necessary at many of the nation's over 20,000 publicly owned treatment works (University of

Michigan, 2012). To put this into perspective, one local wastewater treatment plant for a service volume of approximately 240,000 consumers (annual operating budget of about \$50 million) has estimated the approximate impact of these regulations to require the addition of up to \$60 million in capital improvements to the water treatment infrastructure and systems.

Scenario analysis was performed to examine the outcomes of different input scenarios when looking at the proposed algae biomass system. The base values for this analysis we derived from the feasibility study which had been conducted on the water district (Bioenergy & Environment, 2011). The main outcomes being examined were the capital improvement figures and the operations & maintenance (O&M) figures. These were varied for the different scenarios to pose a “What-if” question for changing different variables. This helps to look at sensitivity of the economics to any one factor as well as looking at the sensitivity of the system’s economics to error in the estimates. For example, what would happen if the true cost of constructing the algae system were 15% or 30% or even 50% higher than the original estimate for capital? Similarly, what would happen if the true O&M costs for the algae system were 15% or 30% or even 50% higher than the original estimate for O&M costs?

The detailed results are available in the Appendix (A.16 – A.20). Shown in the Figure 4.11 are the summary figures. It is a valuable exercise to run through these different scenarios to examine the effect of such changes on both initial (capital) and ongoing (O&M) cost structures. While increasing the effective error of estimation made both the initial and ongoing cost figures for the algal biomass system worsen, they still showed net savings for both establishment and operational costs.

Scenario	Capital Cost Inputs		O& M Cost Inputs		Savings,	Savings,
	Conventional	Algae	Conventional	Algae	Capital	O&M
1	Estimated	Estimated	Estimated	Estimated	\$56.5 M	\$3.64 M
2	15% Less	15% More	Estimated	Estimated	\$48.1 M	\$3.64 M
3	15% Less	30% More	Estimated	15% More	\$47.6 M	\$3.58 M
4	15% Less	30% More	Estimated	30% More	\$47.6 M	\$3.58 M
5	15% Less	50% More	Estimated	50% More	\$46.9 M	\$3.52 M

Figure 4.11: Compiled Results for Algal Biomass Scenario Analyses

One of the challenges here is the uncertainty involved. A public operation like this must be diligent with taxpayer dollars and will not be able to risk the failure of a major capital improvement effort. Thus, it is essential to have confidence and working examples of this type of application in use. There exist a host of academic studies pertaining to the ability of algae to clean up waste water. However, there is a significant gap between scientific studies and positive results at the laboratory scale. The adoption of such a system at scale will be contingent upon bona fide results shown at another installation. In other words, the water treatment facility will not want to purchase a “Serial Number No. 1” system, as this would introduce far too much risk.

The need for risk mitigation techniques for a municipal operation makes good sense. The innovative algae based nutrient removal system will be configured in parallel to the existing system hardware. This configuration will limit risk of the newly added equipment from impacting the current operation. These risk mitigation approaches coupled with real-time information from a working demonstration will help to outline any

system modifications which will be needed to integrate algal biomass approaches to meeting impending nutrient removal regulations for water treatment operations.

Of course, there are numerous variables that a water treatment facility faces and that may impact an algal biomass approach to water treatment and nutrient removal. These factors vary with dynamics such as time of year and ambient conditions. Other sources of variability to be considered include utilization considerations, geographical factors and weather patterns. The wastewater flow rates, solar irradiation, mean operational temperatures of input water and effluent water are included in a systematic consideration of new processing methods, as documented in the A.11, A.14 and A.15 in the Appendix (Bioenergy & Environment, 2011). Also included in the appendix are graphical measures of the influent nitrogen and phosphorous (A.12 and A.13 in Appendix) throughout the year. Although these measures are not specifically analyzed in this research, it is important to validate that these levels are relatively predictable throughout the year. This is especially noteworthy as some approaches with more delicate algae strains, which typically consist of the microalgae species, are more sensitive to ambient conditions. The graphs shown in the Appendix confirm that, while there are dynamics relative to time of year, such changes do not result in extreme spikes or drop-offs in levels that would likely stall or prevent this approach.

The modeling of the algal biomass approach examined how the economics of this approach would vary with respect to changes in capital costs, operations and maintenance costs, and combinations thereof. The results show in favor of the algal biomass approach even if actual capital costs increased 50% over estimates and if the operations and maintenance costs increased by as much as 50% over initial estimates. Thus, this option

would be attractive, given a successful validation of the technological aspects with a demonstration installation.

The complementary biomass co-product that will result from adoption of this approach will be useable for value added biomass applications. Fertilizer and compost may be viable options if such production facilities are located near the water reclamation district. If the biomass were to be dried, it could be converted to thermal and electrical energy forms through conversion methods such as gasification or co-firing. However, this is unlikely due to the high initial moisture content and the need to reduce the moisture level greatly. Thus, the more likely and low hanging fruit opportunity to redeploy the resultant biomass is to add it to the anaerobic digester already in use at the water district. The modeling shown for this case reflects this new use option.

4.3. CASE 3: CUCUMBER STOCK

This research focuses on food processing production leftovers or co-products. The food processing industry, like other production oriented sectors, is becoming more focused on good stewardship of the resources used in and around its production processes. Some of this is encouraged through federal and state regulations; additionally, many operations are held accountable on these metrics by policies derived at a local or organizational level. Many organizations have begun to incentivize regional business units and production facilities to do a better job of creating value from resources and inputs. One way of measuring this is to incorporate built-in metrics to evaluate levels of resources that leave a production facility that are not in a value-added state. Thus, the

production facility will seek to identify new use opportunities for those co-products in order to do a better job of value creation overall. This research utilizes a case based approach.

4.3.1. Introduction to Cucumber Case. The food processing industry and other production oriented sectors have become increasingly focused on being good stewards of the resources used in and around the production processes. Depending on the industry sector and other factors, this may at times be affected by federal and state regulations. However, even when regulations do not mandate such measures, corporations are finding it desirable to adopt these approaches as they lend to environmental consciousness as well as economic prudence. These organizations have begun to grade regional business units and production facilities on how well they are able to create value from the sum total of inputs and resources utilized at a production facility. One way of monitoring this is to incorporate built-in metrics to quantify levels of resources that leave a production facility's envelope in a non-value added form. Thus, the production facility will seek to reduce the amount of production waste leaving the facility and to do a better overall job of value creation.

While the approach may be applied to a broad range of production categories, this research focuses on the food sector and is built around a case examining the production leftovers at a cucumber processing facility. This case explores new use opportunities for a prominent food processor's cucumber co-product fractions. This is in participation with the corporate charter for improved operational sustainability. This opportunity presents a range of options for new uses of biomass in a value added application.

The framework shown in Figure 4.12 addresses the three cores areas strategic planning of algae biomass at a water reclamation district. The supply chain includes the nutrients already present in the water and the biomass which grows in the water and feeds on these nutrients. The transformation realm consists of infrastructure, hardware, and technical knowledge to proactively grow algae to reduce the concentration of nitrogen and phosphorous in waste water; additionally, the hardware will remove the cultured algae from the water. The market opportunity realm focuses on the value creation and in this case will primarily be focused on energy production.

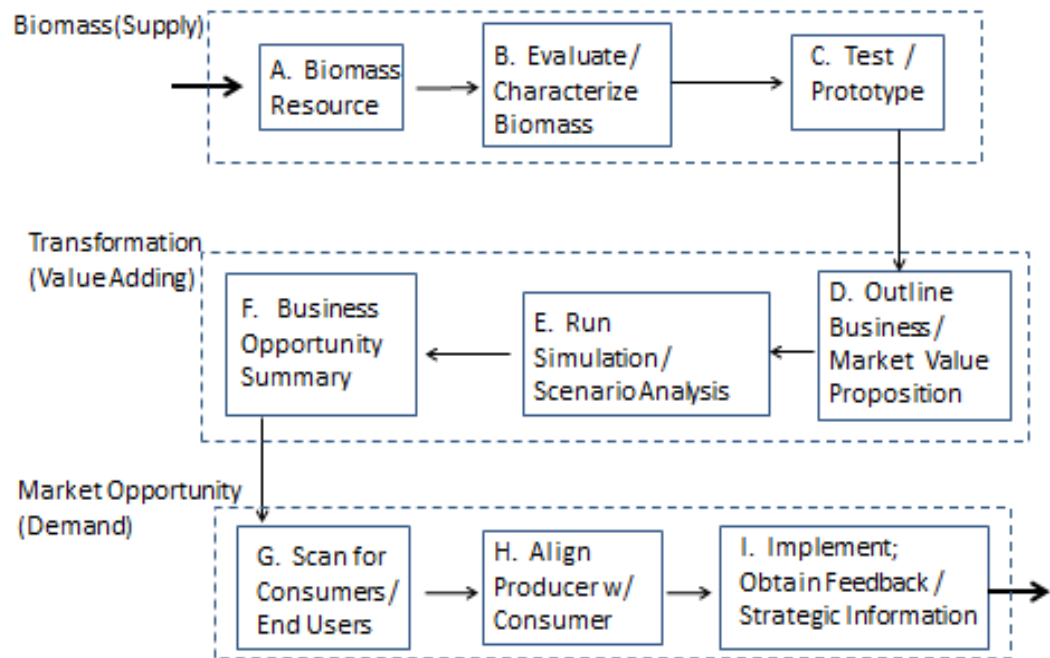

Figure 4.12: Framework of Cucumber Biomass at a Food Processing Facility

4.3.2. Background and Reference. Many production facilities develop internal organizational efforts to reduce waste and the amount of product leaving the production facility footprint that is not in a value added state. Some state-funded and/or consulting agencies help firms to audit for potential waste streams as well as identify and connect with new use opportunities that will derive value from the biomass co-product. Associated with the University of Illinois at Urbana-Champaign, the Illinois Sustainability Technology Center (ISTC) builds relationships with industrial organizations to offer solutions for reducing waste streams that may lead to development of renewable energy. For example, ISTC has linked biofuels production firms with sources of vegetable oil from food processors.

The particular application being explored in this research appears to be unique and there is little published information found regarding prior work on this specific opportunity. There is scholarly literature addressing the utilization of food wastes into energy conversion such as anaerobic digestion. These types of conversions result in methane biogas to power engine generators for production of electrical power and thermal energy.

There are a number of opportunities for re-purposing and creating a new use application for nearly all biomass streams. The process of choosing a specific application may be impacted by a number of factors including quantities, synergistic business opportunities, and other organizations in close proximity. Typically, it does not make economic sense to transport non-value added biomass products over great distances. Thus, for this research, it will be assumed that the more likely applications for creating value out of cucumber biomass will be those in a moderate geographical footprint. A

screening matrix outlines primary opportunities related to this cucumber biomass case (Table 4.3).

Table 4.3: Strategic Outcome Options for Cucumber Biomass Supply Chain

Primary Use	Application	Additional Considerations
Food	Relish product	Need to evaluate cost/benefit
Fuel	Anaerobic digestion	May be evaluated for conversion of sugars to alcohols
Feed	Dairy; chicken	Some hog feeding operations
Fertilizer	Compost; mulch	Blended into bulk recipe
Fiber	Filaments	Development needed
Other	Cosmetics	Lab work required

Bomb calorimeter analysis was used to characterize the cucumber biomass in terms of specific energy. In the condition received, the cucumber biomass had approximately 97% moisture content. The biomass was first dried and then the mass was weighed and recorded. The calorimeter was calibrated prior to testing (see Appendix). The bomb calorimeter measurements indicated approximately 8,195 BTU per lb. on a dry mass basis.

The energy content in the cucumber biomass may be leveraged by densifying the biomass into pellet form. This provides a sturdy, stable means of storing energy for the desired time of use. The cucumber biomass may be blended with additional biomass forms such as native grasses and even glycerol from biodiesel production. Some countries such as Sweden have been using biomass pellets as a replacement for fossil fuel

energy inputs for heating, as have Austria and New Zealand. Pellet stove adoption has also experienced growth in the United States.

4.3.3. Densification. For certain new use opportunities, the cucumber biomass will be tested for pelletization and the ease at which this can be accomplished. This includes both effectiveness and efficiency. Additional research using a pellet mill such as the one shown in Appendix can address additional questions and key considerations for further development. First, can the biomass be pelleted well so that the pellet maintains shape and structural integrity? Secondly, does this have strong potential to be accomplished in an economical manner? Does the moisture inherent in the product serve to help bind the biomass during the pelletization stage? Also, there may be some optimum range of moisture level that lends itself well to pelletization, not too wet so as to gum up or clog the pelletizer, but also not too dry so as to not encourage the biomass to bind and be held together in the pellet form. This was not included as part of the current research effort, although the tests could readily be performed with a pellet mill like the one shown in the Appendix.

4.3.4. Nutritional Composition. In addition to the bomb calorimetry for energy content, addition characterization was included in this case. Certain opportunities may be viable based on the proximate and nutritional composition of the cucumber biomass. This could range from livestock feed applications up to higher value nutraceutical and personal health options. The nutritional information is obtained from the United States Department of Agriculture site. An excerpt has been included in Figure 4.13 to illustrate the observations that the cucumber biomass samples contain significant levels of

Phosphorus and Potassium, both of which are essential nutrients for soil, and are typically included in a blend to replenish soil used in agricultural production.

Minerals				
Calcium, Ca	mg	14	51	1.018
Iron, Fe	mg	0.22	52	0.008
Magnesium, Mg	mg	12	52	0.664
Phosphorus, P	mg	21	51	0.664
Potassium, K	mg	136	52	8.210
Sodium, Na	mg	2	48	0.137
Zinc, Zn	mg	0.17	52	0.013
Copper, Cu	mg	0.071	52	0.017
Manganese, Mn	mg	0.073	52	0.009
Fluoride, F	µg	1.3	11	0.650
Selenium, Se	µg	0.1	41	0.068

Figure 4.13: Nutritional Composition, Cucumber

An analysis was conducted to characterize the base state of the cucumber co-product remaining as part of the food production process. This emphasizes nutritional composition of the cucumber stock. The results are shown in Table 4.4.

Table 4.4: Laboratory Analysis for Cucumber Stock

Analyte	Units	Per 100g
Calories		4.70
Calories from Fat		0.00
Sodium	mg	28.30
Total Carbohydrate	g	0.90
Dietary Fiber	g	<.5
Sugars	g	0.83
Protein	g	0.28
Vitamin C	mg	4.24
Calcium	mg	10.70
Beta carotene	IU	37.00
Fructose	g	0.29
Glucose	g	0.54

4.3.5. Food. A seemingly natural opportunity for utilization of the cucumber co-product is in other uses for human food product offerings and nutritional supplements. One such application may be a relish product. Others may exist, as well. However, it is doubtful that the relatively small volume of biomass this represents would justify a new product development process and the strategic go-to market efforts required for a new product launch.

4.3.6. Feed. Livestock feed may be a new use opportunity for the cucumber co-product. It may be used for hog feed although this would be more suitable for the smaller to medium sized operations. This would not likely be a viable opportunity for larger swine operations as the automated feed systems are sensitive to the feed characteristics

and would not be amenable to transporting this type of biomass product. Modifications to the system would not be justified since the biomass has zero fat content. So, a modestly sized hog operation would provide an outlet for this product which could be one component of a food ration. Dairy and chicken feeding applications would also be explored. For any of these animal feeding applications, this would be considered a low hanging fruit application since no further processing would be necessary. However, logistical factors would need to be considered and due to the relatively low dietary value contributions, these uses would only be justified when the distance from source to point of use is short.

4.3.7. Alcohol Fuel Applications. The cucumber biomass may also be converted into alcohols via fermentation. The sugars may be more readily available than the sugars in some feedstocks being considered for alcohol fuel production. The hydrated state of the cucumber is not as undesirable in this alternate use as it would be in another use such as for combustion/gasification in which the moisture would need to be driven off to a relatively low level, a process requiring infusion of energy. While conversion to alcohol fuels may be an option, it is not given serious consideration at this point as there would need to be relatively large streams of feedstock in order to justify capital equipment. The viability of such an approach may be improved if this feedstock were combined with another available sugar source in relatively close geographical proximity.

4.3.8. Anaerobic Digestion. Another possible alternate for converting the biomass from cucumber processing is the addition of this co-product to anaerobic digestion conversion facilities. Here again, the moisture content built into the cucumber stock is less likely to be problematic and would not likely require de-watering.

4.3.9. Biobased Fertilizer and Compost. The cucumber stock could also be considered as a component in a recipe to make soil amendments or fertilizer through composting. Some agricultural producers have begun composting operation of significant scale. They take in various inputs such as municipal trimmings from yards and trees. This type of a system creates humus and organic matter to enrich the soil and improve soil productivity. The process of making humus compost involved organic matter and a balance of Carbon and Nitrogen, moisture, and porosity. Farmers incorporating this on a larger scale typically adopt a managed process for efficiency and effectiveness. The addition of humus compost to soils recycles nutrients and can improve growing conditions.

The addition of cucumber stock to a humus composting system may offer a number of benefits. First of all, the cucumber biomass represents a renewable, biomass based approach to building soil fertility. Secondly, the introduction of a new use for the production scrap or co-product results in better overall operations at the food production facility. Many such processors have organizational goals and metrics to reduce the amount of product that leaves the facility in a “non-value added” state. Third, there may be economic advantages in that the producer of such “waste” may need to eliminate that product from its production facility, so the farmer may likely be able to procure this feedstock for humus production at low or no cost. Even urban agriculture and local food systems (CMAP, 2012) may find this a valuable input for soil augmentation.

The condition of the cucumber stock as it leaves the food processing facility is a high moisture condition. Although some efforts are made to squeeze the co-product and thereby mechanically expel some of the moisture, the resulting product still retains

moisture. This factor needs to be taken into consideration for new use opportunities. In the humus compost option, moisture is a key component to the overall system and it is desirable. The presence of moisture does, however, affect the geographical distance that makes sense to transport such “wet” product.

The humus compost improves the composition of the soil it is added to. Addition of humus reduces the amount of nitrogen fertilizer that must be added for planting corn. This is important because next to the cost of seed, nitrogen is the second most costly input in the system for corn production. Also, excess nitrogen addition can result in runoff that contaminates creeks and waterways. Therefore, a soil supplement that provides augmentation while reducing the amount of additional nitrogen required may translate into environmental benefits.

The humus compost also works well with lower till agricultural practices. The compost retains moisture and thus may offer advantages in cycles when there is less rainfall or in scenarios where irrigation is not available. Thus, there may be some advantages to humus compost from a conservation standpoint.

This case explores the opportunity to derive value out of a food production waste product, namely cucumber co-product. It utilizes a decision matrix to examine a range of new use categories: food, feed, fiber, fuel, fertilizer, and other uses. The analysis characterized the cucumber biomass in terms of specific energy and nutritional composition. From these results, it is recommended that the food, feed, and fertilizer applications appear most suited for creating value out of the biomass. The exact specifications will be case specific based on factors like new product demand, proximity to target (Rangarajan, et al., 2012) and other existing factors.

5. SYNTHESIZING AND INTEGRATING RESULTS

5.1 EXPANDING THIS EFFORT TO FUTURE OPPORTUNITIES

The following section is based on the synthesis of the results and looks toward expanded application of the biomass new ventures framework; this pertains to future research needs and opportunities. It is based on a research paper submitted by the author (with co-authors) very recently and still under consideration. This lends perspective and helps show what can be done with the biomass entrepreneurship framework in a larger setting.

There has been a renewed interest in entrepreneurship. Wennekers and Thurik (1999) explore the association between entrepreneurship and economic growth; they assert that entrepreneurship occurs in a range of different size organizations, and that larger organizations can deploy corporate entrepreneurship by means of special teams, business units or other strategic configurations “mimicking smallness.” Economic development strategies often include efforts to attract firms to relocate to an area. Other means for spurring development may be through the building of new startup firms within communities as well as fostering innovation and expansion within established organizations. Entrepreneurship is another approach as a development strategy for replacing lost jobs and for creating new jobs (Walzer, 2007).

It is recognized that economic development and entrepreneurial activity are desirable for spurring new business development, growth of existing business and for beneficial impacts on regions. However, the means for recognizing these outcomes is

challenging and often not clear-cut. Often, regions and their respective economic development organizations compete to attract new firms to their geographical areas. The economic development organizations have access to pools of information sources to enable them to facilitate this process. At the same time, we acknowledge the bounded rationality of organizations (Simon, 1991) which can apply both to the economic development organizations and to the entrepreneurs such organizations are seeking to support. Strategic management research related to the resource-based view has highlighted the importance of resources, which may be divided into both resources (including assets) and capabilities (Amit & Schoemaker, 1993). While much of the focus of that research has been on internal use of such resources and capabilities, the present research extends these theories to leverage the value of those resources and capabilities when they are deployed into other strategic configurations. This type of deployment of resources outside their usual spheres may often be a source of profit (Granovetter, 2005).

This research showcases a framework for biobased ventures in an entrepreneur development and economic development context. An area for future improvement of the application of this framework involves the process of how information can be managed so as to enhance the recognition of entrepreneurial opportunities.

One such system will use a database that can enable rapid identification of opportunities that allow two or more companies to benefit from each other's assets. This approach is designed to extend beyond and improve existing economic development approaches using industry classification information. McMullen et al. (2007) assert that the nature of entrepreneurial opportunities is important to gaining better understanding of how markets come into being and function. They further argue that while there has been

significant research on the discovery and exploitation of opportunities, relatively little attention has been given to the nature and source of opportunity itself. According to Vaghely and Julien (2010), linking patterns of information from various sources forms the basis of innovation and new business opportunities. The system outlined in this research will make use of that very process of identifying new sources of and linking with entrepreneurial opportunities.

5.1.1. Collaboration, Alliances and Resource Synergies. Eisenhardt and Schoonhoven (1996) explain that two major reasons firms collaborate or form strategic alliances are strategic needs and social opportunities. The sharing and sourcing of resources may lead to improved strategic positioning. The strength of a firm's social position may be beneficial for strategic alliances since a strong social position helps develop competitive advantages.

Research has shown that reciprocal ties and networks of informal contacts plus access to information and know-how are crucial elements in the development of emergent technology; additionally, cross-fertilization may occur between the business incubator and industry (Rothschild and Darr, 2005). In this research we draw many of the benefits attributed from business alliances and collaboration by gathering the same information these businesses might find because they are in close proximity and dealing with each other frequently.

One example of an interfirm synergy identified is a firm that formulates and manufactures industrial greases and lubricants connected with a biorefinery firm. They begin discussing input and output synergies to explore. The biorefinery has co-product or fractions that do not go into its primary product lines and these fractions are of very low

value to the refinery firm. The lubricant firm, with its eye toward new product development and equipped with a robust chemistry laboratory, begins to explore the possibility of utilizing this biorefinery co-product as a baseline input or building block for new biobased industrial lubricant products.

A second example is a bioscience firm which has been consulting on projects related to algae biomass. This firm is introduced to a large municipal wastewater district. The water district has noticed that algae grow naturally at its processing facility, allegedly due to the high levels of available nutrients present in the water being treated. The bioscience firm declares that algae could be deliberately grown and harvested at the water district in order to perform work. The algae will effectively “eat” the regulated nutrients; this will help the water district remain in compliance with the tightening regulations and have a biomass product harvested with new use opportunities (e.g. bio-fertilizer).

5.1.2. Business Matching and Networks. This research explores a system that assists in matching businesses opportunities and it adds much of the information that may emerge in random fashion in a business setting, for example around the water cooler or by some other means of social interaction. In business networking settings, enterprising individuals and startup businesses have more opportunities to interact which may lead to benefit either in the short-term or long-term. Additional interaction opportunities for entrepreneurs are often facilitated by economic development and Chamber of Commerce organizations, such as meet and greet sessions, newbie introductions, and business community lunches. Each of these efforts provide platforms to learn more about other firms and possibly find benefits through resources held by the other firms; these efforts

encourage exploration and possible development of ties. The authors observe characteristics of those interactions to inform this research effort.

Granovetter (2005) reminds us of the powerful impact of networks on the extent and source of innovation and the diffusion of such innovation. The system in this research may help to extend the network of a firm or entrepreneur. It can be used to find obvious matches, like many commercially available business information systems do; however, it can additionally be used to help identify potential matches which are not obvious. By adding this capability, the system will have an increased likelihood of generating new, non-obvious matches. These new matches represent potential for entrepreneurs to explore new opportunities which may result in the development of businesses and overall increased economic activity. This system combines process and technology for enhanced information management with the intent of positively impacting entrepreneurial opportunity recognition. A unique process for interviewing companies has been developed in which a trained interviewer will draw out a high degree of useful information that will be used in the matching process. The interview captures a wide range of information about the firm, its present business operations, developments and challenges, as well as about areas of emerging interest for the firm's future. In addition, it also strives to find both underutilized resources and waste products that might be useful to another company.

The database serves as the backend to this system and allows for storage and rapid retrieval of information. This system has the capability of not only being manually searched, but also running in an automatic mode; here, the system will search and generate matches. Whether run manually or automatically, it has the opportunity to both

identify matches that conventional information systems used in economic development will and additionally, it will go beyond those capabilities and generate matches and entrepreneurial opportunities based on all the additional information in the database. This research draws upon research foundations from a number of streams of research, including literature related to entrepreneurial opportunity recognition and knowledge (Shane, 2000) and the resource based view in strategic management.

Economic development search processes often rely on industry codes to facilitate rapid searching across large pools of information. The approach being outlined in this research differs from more commonly accepted conventions that use industry codes to match businesses; thus, it represents an innovative approach to economic development searching and matching. There is a blend of both quantitative and qualitative information being captured from interviews using audio tape, and video tape of the facility tour and transferred into the system. So, the approach utilizes both process and technology innovation.

The process is described at a high level. It begins with the economic development organization identifying companies to be contacted. Then, these firms will be asked for the opportunity to conduct a site visit and interview them. The economic development organization will request permission to capture segments of this visit by means of audio/video to increase the amount of information gathered. This will allow for a more free-flowing interview, where the interviewer will not need to be as concerned about taking notes, and can really focus more on the conversation and interaction with the firm being interviewed. The economic development organization will provide assurance that

the firm's information will not be disseminated to others and that this will be used to help identify new entrepreneurial opportunities.

Whenever possible, a pre-assessment will be conducted. This step will allow the company to state its needs or wants. It would be recorded to enable improved transcription when the complete interaction is later debriefed and then populated into the match profile for that particular organization. The site visit provides an opportunity for the economic development professional to learn more about the organization not only through the interview but also by touring the operation. The tour provides an opportunity to scan the operations, ask questions and take note of characteristics such as unique assets and resources. It may be that the firm has taken some of these assets for granted, and that they may be able to be leveraged for value that the firm has not yet recognized. The process, and even the video, may help to highlight "useful waste" and to recognize potential market opportunities for the redeployment of assets and resources.

5.1.3. Audio and Video Capture. The interview at the location of the business organization will include audio recording of the conversation as well as video capture when appropriate. A digital voice recorder is used for the discussion. After the interview, the audio recording is uploaded to a server at the office. This will facilitate transcription of the conversation into a Word document that can be referenced in the future as frequently as necessary. The ability to rely on this recording will free up the interviewer to be much more engaged in the process, since he/she need not be taking notes voraciously and attempting to keep pace with what the interviewee is sharing.

As mentioned previously, a video recording will also be used whenever applicable. This will be applied to the portion of the visit when the business operation is

toured. For example, a manufacturing shop will have many machines that are essential to the core business activities; additionally, there will be supporting infrastructure, hardware, supplies and other resources that may be less directly associated with the core business processes, but they are still needed for the overall business operations. The videotaping will include not only footage of those core process pieces but also everything used or stored at the location. This streaming footage will be invaluable once the interviewer returns to the office, once again alleviating some of the pressure of note taking by the interviewer plus allowing a “re-visiting” or a mental refresh to help the interviewer recall more details and/or become cognizant of new details that were not originally detected. Learning style and cognitive research supports the notion of utilizing different learning channels, including auditory and visual for enhanced learning (Dale, 1969). The video capture will enhance the quality of the information that is retained from the visit to the organization and then subsequently transferred into the information system. Research in the Operations Management literature addresses the importance of the walk-through audit and visual inspection methods for best practices in manufacturing (Flynn et al., 1997).

A wide range of potentially value-generating propositions may be identified through this approach. For example, a site visit and walk-through was made of a firm producing solvents and chemistries for industrial cleaning applications. Visual capture showed a large number of 330-gallon cube-shaped plastic containers or “totes” as they are referred to in the industry. The firm received its input materials for its production operations in these durable containers. However, it was stockpiling these containers onsite and it appeared they were not a source of value for the firm. Meanwhile, it was

observed that another firm in that geographical region was a modestly sized biofuels production facility. Not being as large as an integrated refinery, this firm had smaller, more flexible supply chain options. In the end, this resulted in an entrepreneurial opportunity for a modestly sized intermediary supply chain firm. This intermediary did not have large tanker capabilities necessary to supply large refineries, but rather, this firm collected vegetable oils from food preparation operations. This firm was able to negotiate to procure the totes so that it could more efficiently collect reclaimed cooking oils and then deliver those to the biofuels facility using a medium sized delivery truck. This reduced the overall distribution footprint to help keep that process more economical.

5.1.4. Site Visit. At the site visit, the interviewer starts by talking with the company and expanding on the information given during the pre-site interview. Many of the company's hopes and wishes are discussed. Next the interviewer takes a tour of the facility noting both human resource and material surpluses and shortages. Waste products are identified and cost of disposal is documented. Special attention is given to the responses here as the information provided at this stage can translate into the identification of new opportunities for value creation. The audio recording and the video stream captured during this stage of the process will prove invaluable later for knowledge management.

After the site visit, the economic development professional begins to compile all of the information known about the firm to develop a composite. This includes the pre-site visit discourse, the site interview information, the audio tape the video tour and any other notes from the tour. This information is then transcribed into a list of surplus resources and resources that are desired or would be beneficial. Also recorded are any

potential problems or strategic vulnerabilities which may be of concern in the future. All information will then be inputted into the company's match data profile.

The process starts with an interview onsite at the organization. It begins with a "Voice of the Customer" session (Griffin & Hauser, 1993). Voice of the Customer is a practice currently in use by economic development organizations which helps create the opportunity for learning more about a particular organization. Cooper et al. (2002) refer to this approach as part of a process used by best-practice companies as an intentional discovery stage for new product and innovation efforts. They describe an approach of proactively capturing and handling ideas; otherwise, the reality is that often there is no action taken on ideas. Overall, the Voice of the Customer process seeks to gather information to learn more about the customer's perspectives, which may include expectations and preferences. The information gleaned from these "Voice of the Customer" interactions will serve to better inform the firm in terms of marketing, product development and strategy. For the purposes of this research, the Voice of the Customer interview is a starting point that invokes the dialogue, helps the customer to open up and share information, and then provides a platform from which to springboard to additional conversation that is less structured and really more open for the customer to articulate and provide input.

The "Voice of the Customer" interview process for economic development organizations typically utilizes a structured questionnaire with stock questions about the firm and its relationship to and satisfaction with the region (e.g. utilities, suppliers, technology providers, etc.). In addition to those, this research will add new questions such as "What specific resources would your organization want more access to?" and

“What unused materials/products (e.g. waste, production scrap) does your operation have?” The interviewer will also ask the firm representative “What capabilities and/or capital does your firm have that are not being fully utilized?” and “What operational ‘leftovers’ or ‘co-products’ does your firm have?” Overall, this process will empower the interviewer to draw out rich information to expand the database with a range of information. It is believed the wide range of information that can be captured and managed will enhance the potential for discovering new opportunities through this search process, which will be tested in the future.

The questions help draw out useful information during the interview to identify gaps and opportunities for value chain development and management. As part of the site visit, the interviewer will observe opportunities to benefit the business and seek to identify possible waste products which may have value for a different company or in a different application. Here, we define “resources” broadly to include human capital, production surplus, scrap or co-products from the operations, and hardware and assets from the physical plant. Overall, these may be assets that are underutilized or do not offer value to the organization.

Ideally, the information seeking efforts will include one or more site visits to the firm. A virtual tour conducted by the interviewer frequently will be employed, which will provide initial information about the organization’s input/output needs and supplies. Interviewer preparation will include training to maximize the potential for rich information gathering, as well as to provide a consistent framework for the interview process. The process of visiting a firm can be very beneficial in a number of ways. The interviewer comes in with a fresh perspective. So, when he/she views the operation,

there may be certain observations that prompt questions and discussion (e.g. “Why does the machine operator do this?” or “What happens to the leftover production materials that do not get converted in the transformation process?”). The fact that the interviewee is speaking to someone who has not heard this before and is listening intently may prompt the interviewee to share more information. This may result in a statement of problems or wishes that would benefit the organization. The interviewer will capture these through the audio recording, and this rich information may prove valuable at a later point. The opportunity to walk through the business operations may provide much more information to an observant visitor. Consequently, the site visit outcomes will correspond to the interviewer’s ability to draw out information from the firm.

5.1.5. Information System for Matching. The system outlined above is an innovative approach to increasing the rate of business connections with the purpose of helping to allocate or reallocate resources and assets to be deployed more effectively. The database system will be based on a relational database model developed using Microsoft Access for both the database and the application. Beyond the system itself, the process of capturing and storing firm information is unique since the audio and video techniques encompass much more of the firm's information. This gives the researchers a chance to find more of the information available about the firm which translates into a higher likelihood of identifying matches.

6. LIMITATIONS OF THIS STUDY

This research utilizes a case study approach. There are some inherent benefits to this type of research including the ability to gain deep insights and rich information in the investigation. However, there are also some limitations due to the small sample size which affect the generalizability of research findings. Future works should be investigated on a detailed case specific basis as there are a variety of factors that impact new venture projects. Additionally, similar projects may be identified to serve as analogs for the case of simulations; these examples may provide added inputs for the modeling in terms of imputed values and clearer definition of the simulation domain.

Economic development efforts include a wide range of inputs including existing asset bases, strength of networks, support of local organizations and elected officials, economic incentives, and more. Entrepreneurial startups come with a host of variables including the management team, their network base, existing resources and skills, technology assets/intellectual property, and more. As one can envision, the variability and scope of potential projects holds vast potential; this creates much opportunity while at the same time makes it challenging to an economic development organization in how to frame up and examine different strategic options. This research -while not covering all the possibilities- offers a framework for a systematic approach to identifying and exploring current and emergent strategic options for rural entrepreneur development with biomass.

Demonstration projects may also increase validity in the estimated values being used in simulation. As stated earlier, the availability of a consistent source of biomass inputs is essential to long term viability of the venture; this will also vary on a project-specific basis and should be given careful consideration.

7. SYNTHESIZING AND INTEGRATING RESULTS

7.1. SUMMARY

This research developed a framework for evaluating a vast array of biomass related new venture opportunities which may be considered for entrepreneurship and economic development. This comes at a time when the success of these ventures could be considered critical. Rural areas tend to be hit harder in terms of workforce opportunities. Energy considerations are on the minds of both consumers and producers. Farmers are seeking new opportunities for differentiation and value added outlets. Hence, the potential value of a tool to assist in evaluating new opportunities. Such evaluation need not be limited to a Go/No go decision; rather, the ability to explore different strategic options and examine different value propositions may be beneficial.

The three cases were used to help illustrate how such a tool may prove useful. The framework may prove especially helpful to economic development organizations, in order to help systematize the methods used to work on project opportunities related to biomass ventures. The biodiesel case focused on a modestly sized plant with more of a regional approach and supply chain strategy; here the input sourcing can be from a relatively small swept radius and the market channels can similarly be in or near surrounding metropolitan and suburban centers of consumption.

The algae biomass case looked at a new use for a biomass form that is typically considered a nuisance growth at water reclamation districts; here, the basis for entrepreneurial opportunity is being motivated in part by impending regulations for lower

nutrient discharge levels. The technological innovation involves taking algae's natural propensity to grow at a water district and leveraging that to reduce the levels of nitrogen and phosphorous –nutrients which the algae feed on and which are regulated by environmental policy- which are present in the water being returned to streams and local water tables. The caveat here is that once the work of reducing nitrogen and phosphorous –without expanded chemical treatment methods- has been completed, the water district will have a supply of biomass from which to extract value.

The third case is an example of a biomass supply being generated by a food processing facility. The case highlights a cucumber processing facility which has production leftovers which do not end up in the final product package, and thus need to be diverted from the processing facility. Corporate policies are giving more scrutiny to products leaving the facility that are not in a value-added form. More and more, organizations will develop scorecard systems to help their production centers to do a better job in terms of environmental stewardship and economic prudence with resources. This type of application is also important as it could fan out to a wide range of biomass co-product streams being sourced from food processors.

Overall, these cases show the importance of the supply chain elements to any prospective new venture. The efforts will be benefitted by collaboration, innovation, and strategic partnering/alliances. In some cases, agricultural producers may be vital stakeholder including how to ensure longer term supply streams and expertise.

7.2. RECOMMENDATIONS

The framework outlined and explained above provides a basis for identifying and exploring new uses applications of biomass in entrepreneurship and economic development realms. The typology with the five basic F's (food, feed, fiber, fuel, fertilizer, plus "other" category) is helpful to keep these categories at the top of mind when looking at how best to deploy biomass resources.

A knowledge management system or custom information system will also be helpful. Here, one will ultimately devise a schema or approach for housing the growing base of information. This will help categorize information on available resources and assets, as well as enable systematic approaches to identifying potential matches. Then, it will be up to the human judgment of a professional to offer to establish a linkage. Decision analyses may then be run to give consideration to various strategic options and specific scenarios. The usefulness of this will be proportional to the degree to which it can be stocked with rich information which may result in significant findings and outliers leading to very unique and lucrative opportunities.

The value of this type of framework for entrepreneurship development will be linked to how well it is implemented as a strategic tool. The more engaged the economic development organization is with entrepreneurs and collaborators, the greater the likelihood of successful outcomes. Like a bricks and mortar incubator, there will be some success stories as well as other stories of endeavors that did not go as planned and/or may be waiting for the right strategic opportunity which will lead to a success story. All of this will require proactive efforts to build a climate of collaboration, manage communications and messaging to maintain high levels of interest and

engagement, and maintain an atmosphere conducive to innovation and entrepreneurial action.

7.3 IMPLICATIONS FOR ENGINEERING MANAGERS

Biomass ventures are well suited for the engineering management discipline. The blend of engineering, business, and technology is important for evaluating many of the types of projects involved in entrepreneurial ventures. A certain degree of technical aptitude and awareness can help the manager to know the types of questions to be addressed especially for technology purchases and infrastructure that may be used to transform the biomass into value added products for markets. This awareness and scrutiny in the early project stages may help lessen the likelihood of major technical problems at the time of the new venture launch and beyond.

Engineering managers are trained to bridge the gap and operate at that interface of the technical and the business/market realms. Thus, they may possess some inherent advantages for working with these types of economic development opportunities. If trends toward biorenewable products, environmentally sound practices, and conversion technologies continue to advance, engineering managers and recent graduates are likely to find employment opportunities related to this area. This may also include technology based entrepreneurship, an area which Shane (2005) describes as featuring greater likelihood of success when compared with low-technology startups.

7.4. CONTRIBUTIONS TO THE LITERATURE

This research will make a scholarly contribution through the establishment of a framework for biobased ventures. The framework is aimed at rural economic development and will facilitate the alignment of three key elements: biomass resources/supply chains, business marketplace conditions/opportunities, and strategic entrepreneurial actions. It provides a tool for systematic evaluation of various new venture options for rural economic development and entrepreneurship.

The entrepreneurial ventures represented in this research will likely involve innovation and new approaches by their very nature. Regional approaches may be given more consideration in efforts to maintain relatively smaller and distributed footprints. This will be due at least in part to the fact that biorenewable resources have some inherent disadvantages when compared with fossil resources with which they often compete. Biorenewable resources have lower bulk density, higher moisture affinity, and are not as readily transported in large quantities by methods like pipelines. (Brown, 2003). Smaller farm operations, specialty crops, and even urban agriculture will dovetail well with an innovation mindset and the search for new entrepreneurial opportunities with biomass.

This research offers insights to a number of realms in the literature. The rural economic development attributes are important due to the resources held in those regions and the opportunities they represent in terms of innovation, productivity, and workforce. New ventures related to biomass will leverage domestic supply chains, may offer environmental benefits, and may present new employment opportunities and earning potential.

7.5. FUTURE RESEARCH

This research may be expanded upon in the future in a number of ways. It may be beneficial to scan other locales and nations who have for years utilized biomass for economic development, such as Sweden (Hillring, 2002); while there may be some distinct differences in political and economic factors, the analysis may shed light on new ideas for strategic implementation of biomass ventures into economic development. The framework may be further validated through expanded testing with a larger pool of information and through application of organizational network analysis. Much of this information will be able to be captured and stored by economic development organizations working with firms and entrepreneurs through the existing Voice of the Customer procedures. The site visits to business operations will be insightful and can really help inform this process, since new ideas are often sparked by seeing things and envisioning what may be possible. Finally, this research will be strengthened through the deployment of an economic development knowledge management system designed intentionally for the purpose of automatically searching and finding strategic matches for entrepreneurial opportunity identification.

Biodiesel Case

Sales Scenario 3, Commodity Input Costs					
Market Condition	Volume	Price			
Strong Market	1 5,000,000	\$ 4.50			
Stable Market	2 4,000,000	\$ 4.40			Analysis
Slow Market	3 3,500,000	\$ 4.30			Sales scenario 3
					Sales Volum 3,500,000
Production Costs					Selling Price \$ 4.30
	(inputs including vegetable oil)				Unit Cost \$ 2.20
Low	\$ 2.00				
Moderate	\$ 2.50				Net Profit \$ 865,670
High	\$ 2.75				Average Profit \$ 91,626
Fixed Costs	\$ 6,500,000				

A.3: Base Case (Commodity Inputs), Sales Scenario 3, Volume in Gallons

Biodiesel Case

Sales Scenario 1, Improved Production Input Costs			
Market Condition	Volume	Price	
Strong Market 1	5,000,000	\$ 4.50	Analysis Sales scenario 1 Sales Volume 5,000,000 Selling Price \$ 4.50 Unit Cost \$ 1.88
Stable Market 2	4,000,000	\$ 4.40	
Slow Market 3	3,500,000	\$ 4.30	
Production Costs (inputs including vegetable oil)			
Low	\$ 1.50		
Moderate	\$ 2.25		
High	\$ 2.50		
Fixed Costs	\$ 6,500,000		
			Net Profit \$ 6,586,199
			Average Profit \$ 5,583,314

A.4: Improved Production Cost (Alternate Inputs), Sales Scenario 1, Volume in Gallons

Biodiesel Case

Sales Scenario 2, Improved Production Input Costs			
Market Condition		Volume	Price
Strong Market	1	5,000,000	\$ 4.50
Stable Market	2	4,000,000	\$ 4.40
Slow Market	3	3,500,000	\$ 4.30
Production Costs			
(inputs including vegetable oil)			
Low	\$	1.50	
Moderate	\$	2.25	
High	\$	2.50	
Fixed Costs \$ 6,500,000			
		Analysis	
		Sales scenario	2
		Sales Volum	4,000,000
		Selling Price	\$ 4.40
		Unit Cost	\$ 1.84
		Net Profit	\$ 3,721,798
		Average Profit	\$ 2,766,582

A.5: Improved Production Cost (Alternate Inputs), Sales Scenario 2, Volume in Gallons

Biodiesel Case

Sales Scenario 3, Improved Production Input Costs			
Market Condition	Volume	Price	
Strong Market	1	5,000,000	\$ 4.50
Stable Market	2	4,000,000	\$ 4.40
Slow Market	3	3,500,000	\$ 4.30
Production Costs			
(inputs including vegetable oil)			
Low	\$	1.50	
Moderate	\$	2.25	
High	\$	2.50	
Fixed Costs \$ 6,500,000			
Analysis			
Sales scenario			3
Sales Volum			3,500,000
Selling Price			\$ 4.30
Unit Cost			\$ 1.88
Net Profit			\$ 1,955,587
Average Profit			\$ 1,258,371

A.6: Improved Production Cost (Alternate Inputs), Sales Scenario 3, Volume in Gallons

Biodiesel Case



A.7: Local Canola Test Plot

Biodiesel Case



A.8: Industrial Shop Heater

Dust Control Application for Rural Roads



A.9: Typical Dust Control Applicator System

Algae Case

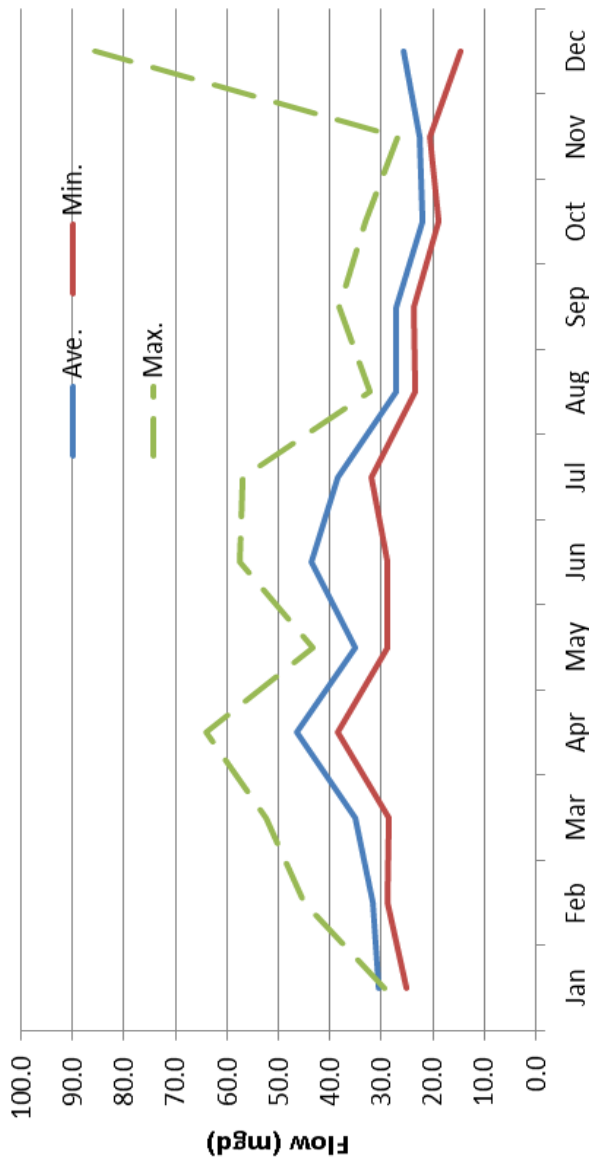

A.11: Seasonal Wastewater Flow at Regional Plant (Rockford, IL)

Algae Case

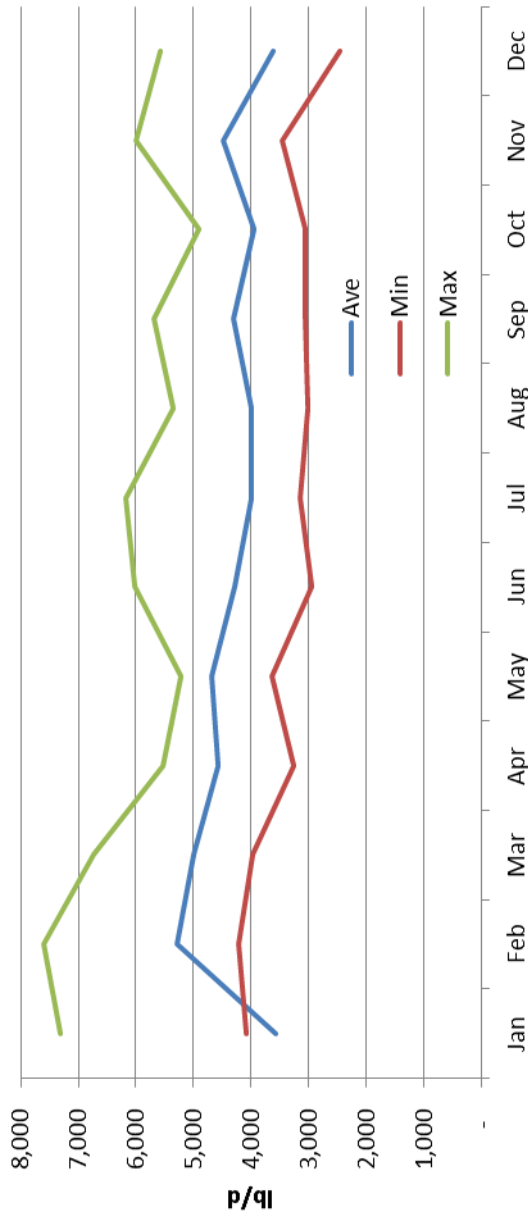

A.12: Influent Nitrogen Flux (Rockford)

Algae Case

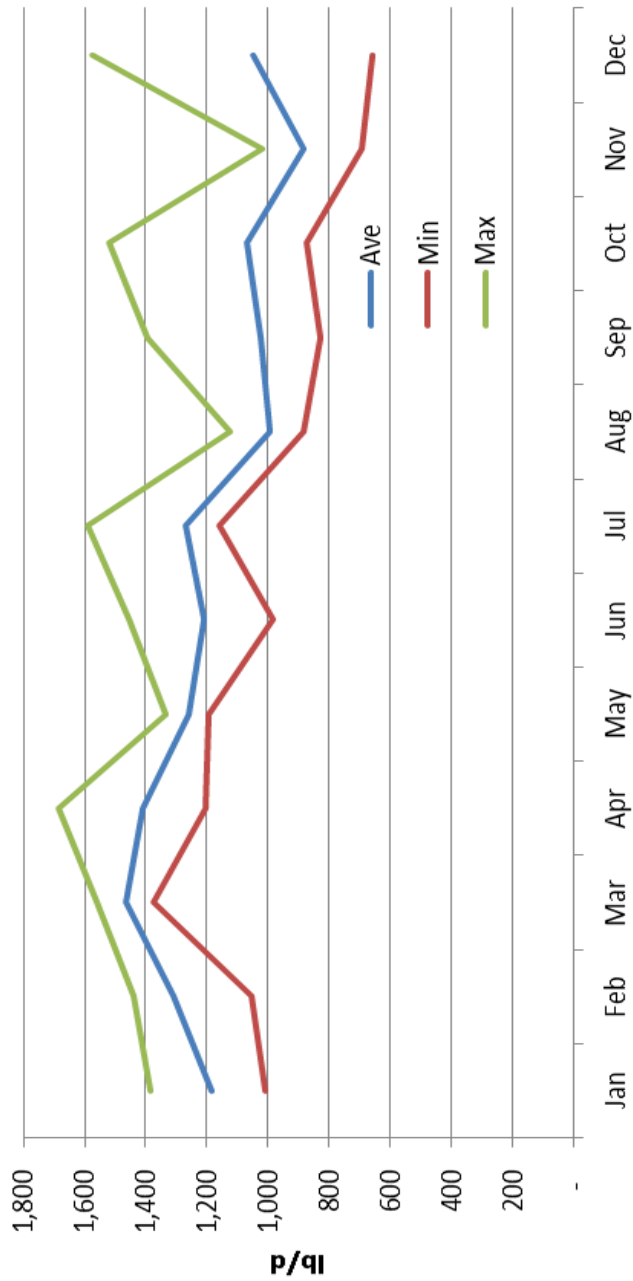

A.13: Influent Phosphorus Flux (Rockford)

Algae Case

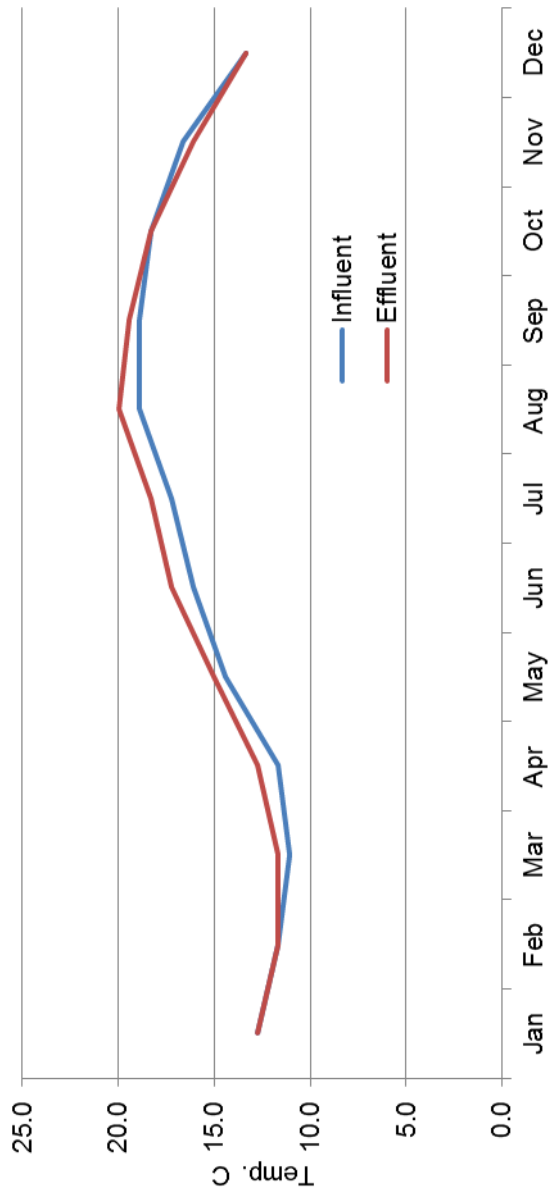

A.14: Seasonal Flux Influent and Effluent Wastewater Temperature (Rockford)

Algae Case

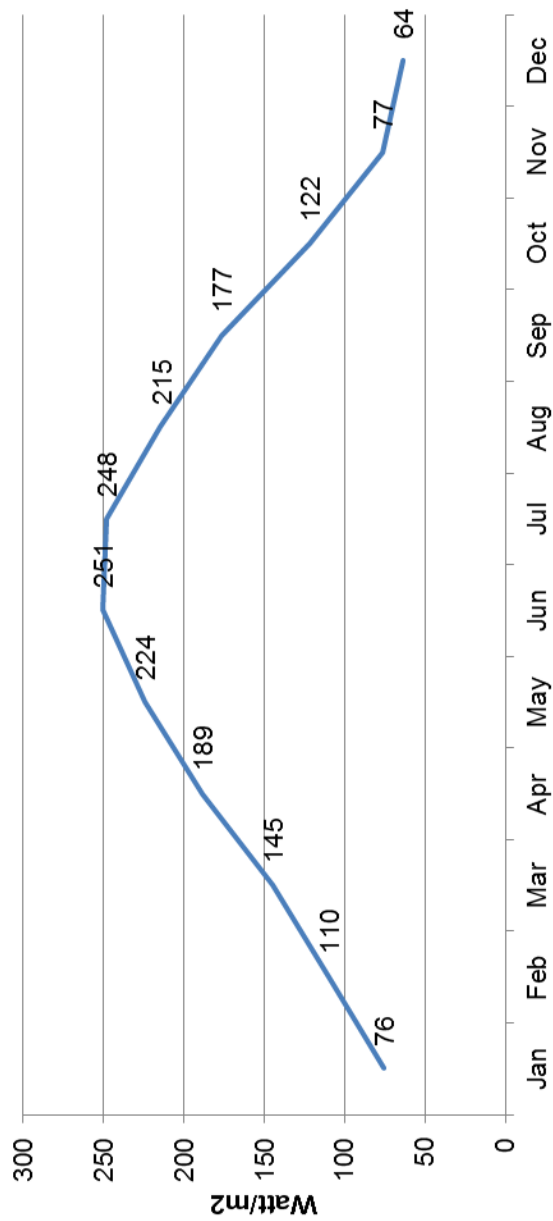

A.15: Seasonal Solar Irradiation (Rockford)

Algae Wastewater Case

Scenario 1	Base Case			
Capitalization	\$60 Million Capitalization for Conventional Approach (CA) \$3.5 Million Capitalization for Algae Biomass Approach (ABA)			
Approach		Conventional	Algae	
Capital Cost		60,000,000	3,500,000	
		Net savings, capital	\$56,500,000	
Annual operations				
O & M Cost		3,050,000	417,800	
Algae Value				
***lipid costs			-581,800	
***biomass cost			-427,000	
Total O&M cost		3,050,000	-591,000	
		Net savings, O&M	\$3,641,000	

A.16: Scenario 1 with \$60 M Capitalization for Conventional Approach (as estimated), \$3.5 M Capitalization for Algae Biomass Approach (as estimate)

Algae Wastewater Case

Scenario 2			
CA Capitalization 15% less; ABA 15% more			
Capitalization			
\$52.2 Million Capitalization for Conventional Approach (CA)			
\$4.0 Million Capitalization for Algae Biomass Approach (ABA)			
ABA operation held constant			
Approach	Conventional	Algae	
Capital Cost	52,173,913	4,025,000	
	Net savings, capital	\$48,148,913	
Annual operations			
O & M Cost	3,050,000	417,800	
Algae Value			
***lipid costs		-581,800	
***biomass cost		-427,000	
Total O&M cost	3,050,000	-591,000	
	Net savings, O&M	\$3,641,000	

A.17: Scenario 2 with \$52.2 M Capitalization for Conventional Approach, \$4.0 M Capitalization for Algae Biomass Approach

Algae Wastewater Case

Scenario 3	CA Capitalization 15% less; ABA 30% more	
Capitalization	\$52.2 Million Capitalization for Conventional Approach (CA) \$4.6 Million Capitalization for Algae Biomass Approach (ABA) ABA operation increased by 15%	
Approach	Conventional	Algae
Capital Cost	52,173,913	4,550,000
	Net savings, capital	\$47,623,913
Annual operations		
O & M Cost	3,050,000	480,470
Algae Value		
***lipid costs		-581,800
***biomass cost		-427,000
Total O&M cost	3,050,000	-528,330
	Net savings, O&M	\$3,578,330

A.18: Scenario 3 with \$52.2 M Capitalization for Conventional Approach, \$4.6 M Capitalization for Algae Biomass Approach (ABA), O&M Costs 15% higher than Estimated on ABA

Algae Wastewater Case

Scenario 4	CA Capitalization 15% less; ABA 30% more	
Capitalization	\$52.2 Million Capitalization for Conventional Approach (CA) \$4.6 Million Capitalization for Algae Biomass Approach (ABA) ABA operation increased by 30%	
Approach	Conventional	Algae
Capital Cost	52,173,913	4,550,000
	Net savings, capital	\$47,623,913
Annual operations		
O & M Cost	3,050,000	543,140
Algae Value		
***lipid costs		-581,800
***biomass cost		-427,000
Total O&M cost	3,050,000	-465,660
	Net savings, O&M	\$3,515,660

A.19: Scenario 4 with \$52.2 M Capitalization for Conventional Approach, \$4.6 M Capitalization for Algae Biomass Approach (ABA), O&M Costs 30% higher than Estimated on ABA

Algae Wastewater Case

Scenario 5	CA Capitalization 15% less; ABA 50% more	
Capitalization	\$52.2 Million Capitalization for Conventional Approach (CA) \$5.3 Million Capitalization for Algae Biomass Approach (ABA) ABA operation increased by 50%	
Approach	Conventional	Algae
Capital Cost	52,173,913	5,250,000
	Net savings, capital	\$46,923,913
Annual operations		
O & M Cost	3,050,000	543,140
Algae Value		
***lipid costs		-581,800
***biomass cost		-427,000
Total O&M cost	3,050,000	-465,660
	Net savings, O&M	\$3,515,660

A.20: Scenario 5 with \$52.2 M Capitalization for Conventional Approach, \$4.6 M Capitalization for Algae Biomass Approach (ABA), O&M Costs 50% higher than Estimated on ABA

Cucumber Case



A.21: Calibrated Fuse Wire for Oxygen Bomb Calorimeter



A.22: Digital Readout of Experimental Results



A.23: Configuration of Cucumber Sample in Bomb Calorimeter

Cucumber Case

Calibration of the Bomb Calorimeter

	Run #1	Run #2	Run #3	Run #4	Run #5	Run #6	Run #7	Run #8	Run #9	Run #10
Wt. Benzoic Acid + wire	0.7645	0.8975	0.9146	0.8304	0.8178	0.7537	0.7772	0.7638	0.8369	0.7620
Wt. wire	0.0149	0.018	0.0156	0.0142	0.0122	0.0188	0.0128	0.0115	0.0135	0.0145
Wt. Benzoic acid	0.7496	0.8795	0.899	0.8162	0.8056	0.7349	0.7644	0.7523	0.8234	0.7475
Wt. wire initial	0.0149	0.018	0.0156	0.0142	0.0122	0.0188	0.0128	0.0115	0.0135	0.0145
Wt. wire final	0.0085	0.0151	0.0094	0.0100	0.0070	0.0154	0.0109	0.0055	0.0083	0.0090
Wt. wire burned	0.0064	0.0029	0.0062	0.0042	0.0052	0.0034	0.0019	0.0060	0.0052	0.0055
T(initial)	21.061	21.035	19.575	4.418	3.440	22.005	22.590	20.410	20.495	21.125
T(final)	23.015	23.318	21.912	2.280	1.338	23.914	24.587	22.362	22.610	23.078
dT	1.954	2.283	2.337	2.138	2.102	1.909	1.997	1.952	2.115	1.953
dU (benzoic acid)	-19804	-23236	-23752	-21564	-21284	-19416	-20195	-19876	-21754	-19749
dU (wire)	-37	-17	-36	-25	-30	-20	-11	-35	-30	-32
dU (total)	-19842	-23253	-23788	-21589	-21314	-19436	-20207	-19911	-21785	-19781
Heat capacity, C (J/K)	10155	10185	10179	10098	10140	10181	10118	10200	10300	10129

Average C (J/K) **10169**Std Deviation **57**%RSD **0.56** ΔU (benzoic acid)

-26420

J/g burned

5858

J/g burned

Cp results

Statistics for C	
Mean	10169
Std Error	18
Median	10167

Cucumber Case



A.27: Biomass Pellets



A.28: Biobased Composting



Cucumber Case

A.29: Moisture meter



A.30: Probe for Sampling Moisture Content

BIBLIOGRAPHY

- Amit, R. and Schoemaker, P.J.H. "Strategic assets and organizational rent." *Strategic Management Journal*, Vol. 14, No. 1, Pp. 33-46 (1993).
- Barkema, Alan D. "AgBiotech: Bold New Promise or Bold New Risk?" *The Main Street Economist: Commentary on the Rural Economy* (October 2000).
- Barringer, B. and R. Ireland. *Entrepreneurship: Successfully Launching New Ventures*. Pearson Prentice Hall: Upper Saddle River, NJ (2006).
- Bioenergy & Environment. "Feasibility of Integrating Algae Cultivation Into RRWRD's Wastewater Treatment Plant." With Department of Energy funding Award Number DE-FG36-04GO14231 (March, 2011).
- Birch, David. *Job creation in America: How our smallest companies put the most people to work*. Free Press: New York, NY (1987).
- Bollingtonft, A. and J.P. Ulhoi, "The networked business incubator –leveraging entrepreneurial agency?" *Journal of Business Venturing*, Vol. 2, No. 2, Pp. 265-290 (2005).
- Bourdieu, Pierre. *The Forms of Capital*, originally published as *Ökonomisches Kapital, kulturelles Kapital, soziales Kapital* in *Soziale Ungleichheiten* (Soziale Welt, Sonderheft 2), edited by Reinhard Kreckel. Otto Schartz & Co.: Goettingen (1986).
- Brown, R. *Biorenewable Resources: Engineering New Products from Agriculture*. Iowa State Press. Ames, IA (2003).
- Burns, T. and G.M. Stalker, *The Management of Innovation*, Oxford University Press: New York, NY (1994).
- Choi, T.Y., K.J. Dooley, and M. Rungtusanatham. *Supply networks and complex adaptive systems: control versus emergence*. *Journal of Operations Management*, Vol. 19, No. 3, Pp. 351-366 (2001).
- CMAA (Chicago Metropolitan Agency for Planning). www.cmap.illinois.gov/food/about.

Cohen, W. M., and D.A. Levinthal. "A New Perspective on Learning and Innovation." *Administrative Science Quarterly*, Vol. 35, No. 1, Special Issue: Technology, Organizations, and Innovation, Pp. 128-152 (March, 1990).

Cooper, R. G., S.J. Edgett, and E.J. Kleinschmidt. "Optimizing the Stage-Gate Process: Best-Practice Companies Do." *Research-Technology Management*, Vol. 45, No. 5 (2002).

Council on Competitiveness. *Innovate America – National Innovation Initiative Summit Report*. www.compete.org (2004).

Drabenstott, Mark. "New policies for a new rural America." *International Regional Science Review*. Vol. 24, No. 1, Pp. 3-15 (2001).

Drucker, Peter F. *Innovation and Entrepreneurship*. New York, NY: Harper & Row, Publishers, Inc. 1986

Drucker, Peter F. "Business Objectives and Survival Needs: Notes on a Discipline of Business Enterprise." *The Journal of Business*, Vol. 31, No. 2, Pp. 81-90 (1958).

Dale, E. "Audiovisual Methods in Teaching." Holt, Rinehart and Winston, Inc.: New York, N.Y (1996).

Eisenhardt, K.M. and C.B. Schoonhoven. "Resource-Based View of Strategic Alliance Formation: Strategic and Social Effects in Entrepreneurial Firms." *Organization Science*, Vol. 7, No. 2, Pp. 136-150 (1996).

Eisenhardt, Kathleen. "Building theories from case study research." *Academy of Management Review*, Vol. 14, Pp. 532-550 (1989).

Eschenbach, Ted G. *Engineering Economy*. 2nd Edition. Oxford University Press: New York, NY (2003).

Fortenbery, T. R. *Biodiesel Feasibility Study: An Evaluation of Biodiesel Feasibility In Wisconsin*. University of Wisconsin, Madison, Department of Agriculture & Applied Economics, Madison, Wisconsin (2005).

Frontline Solvers. www.solver.com (2012).

- Graceffa, Steve. Personal Interview. Rock River Water Reclamation District, Rockford, IL. March and October 2012.
- Granovetter, Mark. "The Impact of Social Structure on Economic Outcomes." *Journal of Economic Perspectives*, Vol. 19, No. 1 (2005).
- Griffin, A. & Hauser, J.R. "The Voice of the Customer." *Marketing Science*, Vol. 12, No. 1 (1993).
- Growth Dimensions. Economic Development for Belvidere-Boone County; The AgTech Initiative. www.growthdimensions.org/agtech.asp (2012).
- Gwartney, J.D., R.L. Stroup & R.S. Sobel. *Economics: Private and Public Choice*. 9th edition, The Dryden Press: Fort Worth, TX (2000).
- Hebert, R. and Link, A. "The Entrepreneur as Innovator." *Journal of Technology Transfer*, Vol. 31, Pp. 589-597 (2006).
- Henderson, R., A. Jaffe, and M. Tratjenberg. "Patent Citations and the Geography of Knowledge Spillovers: A Reassessment: Comment." *The American Economic Review*, Vol. 95, No. 1, Pp. 461-464 (2005).
- Hillring, Bengt. "Rural Development and Bioenergy – Experiences from 20 Years of Development in Sweden." *Biomass and Bioenergy*, Vol. 23, Pp. 443-451 (2002).
- Hills, Gerald. *Marketing and Entrepreneurship: Research Ideas and Opportunities*. Quorum Books: Westport, CT. (1994).
- Jacobs, F. and B. Chase. *Operations and Supply chain Management: The Core*. McGraw-Hill: New York, NY (2008).
- Klobas, J.E. and P.D. Jackson. "Becoming Virtual: Knowledge Management and Transformation of the Distributed Organization." Physica-Verlag: Heidelberg, Germany (2008).
- Little, B., R. Cooper, and R. More. "Putting Market into Technology to Get Technology into Market." *Business Quarterly*, Vol.37, No. 2, P. 62 (1972).
- Long, S., and E. Cudney. "Integration of Energy and Environmental Systems in Wastewater Treatment Plants." *International Journal of Energy and Environment*. Vol 3, Issue 4, Pp 521-530 (2012).

- Low, S., J. Henderson, S. Weiler. "Gauging a Region's Entrepreneurial Potential," *Economic Review*, 3rd Quarter, Pp.61-89 (2005).
- Mackie, B., and N. Ziemer. "Entrepreneurial Business Linkages via Strategic Information Systems." *Issues in Information Systems*. Vol. 13, No. 2, Pp. 361-368 (2012).
- McMullen, J. S., L.A. Plummer, and Z.J. Acs. "What is an Entrepreneurial Opportunity?" *Small Business Economics*, Vol. 28, No. 4 (2007).
- March, James. "Exploration and Exploitation in Organizational Learning." *Organization Science*, Vol. 2, No.12, Pp. 71-87 (1991).
- Mirza, A., N. Ziemer, R. Tatara, R. Moraga, C. Mirman, P. Vohra. "Biodiesel Fuel Costs and Environmental Issues when Powering Railway Locomotives." *Proceedings of the World Energy Council*. Montreal (2010).
- Mulkey, D. and A. Hodges. "Using IMPLAN to Assess Local Economic Impacts." University of Florida, Institute of Food and Agricultural Sciences, IFAS Extension (2009).
- Murray, S., A. Alpaugh, K. Burgher, B. Flachsbart, and C. Elrod. "Development of a Systematic Approach to Project Selection for Rural Economic Development." *Journal of Rural and Community Development*, Vol. 5, No. 3, Pp. 1-18 (2010).
- Murphy, Patrick. Personal Interview. Belvidere Township. Belvidere, IL. October 2012.
- National Federation of Independent Business, www.nfib.com. (2012)
- NIU Regional Development Institute. "The Economic Impact of a Biodiesel Fuel Manufacturing Facility on the Illinois Economy." (2009)
- NIU Regional Development Institute. "Glycerin Energy Analysis." (2008)
- Pages, E.R., D. Freedman, and P.V. Bargen. "What Makes a Region Entrepreneurial?" *Economic Development Quarterly*, Vol. 24, No. 4, Pp. 12-19 (2001).
- Pernick, R. and C. Wilder. *The Clean Tech Revolution: Discover the Top Trends, Technologies, and Companies to Watch*. Harper Collins: New York, NY (2008).
- Porter, Michael. *Competitive Strategy*. Free Press: New York, NY (1998).

- Rangarajan, K., N. Ziemer, and S. Long. "Public-Private Partnerships and Rural Economic Development." *IERC Proceedings*. Miami, FL (2009).
- Rangarajan, K., N. Ziemer, and S. Long. "Strategic Planning and Rural Economic Development: An Evaluative Case Study Approach to the Use of Public-Private Partnerships in High Risk Transportation Projects." *American Society of Engineering Management*. Springfield, MO (2009).
- Rangarajan, K., S. Long, N. Ziemer, and N. Lewis "An Evaluative Economic Development Typology for Sustainable Rural Economic Development," *Community Development*, Vol. 43, No. 3, Pp. 320-332 (2012).
- Rogers, Mark. "Networks, Firm Size, and Innovation." *Small Business Economics*, Vol. 22, No. 2, Pp. 141-153 (2004).
- Rothschild, L. & A. Darr. "Technological Incubators and the Social Construction of Innovation Networks: an Israeli Case Study." *Technovation*, Vol. 25, No. 1, Pp. 59-67 (2005).
- Ruttan, Vernon. *Technology, Growth and Development*. Oxford University Press: New York, NY (2001).
- Schumpeter, Joseph. *Capitalism, Socialism, and Democracy*. Harper Torchbooks: New York, NY (1950).
- Schumpeter, Joseph. "Translations from Theorie der Wirtschaftlichen Entwicklung." *American Journal of Economics and Sociology*, Vol. 61, No. 2, Pp. 405-438 (2002).
- Shane, Scott. "Finding Fertile Ground: Identifying Extraordinary Opportunities for New Ventures." *Pearson Education, Inc.*: New York, NY (2005).
- Shane, Scott. "Prior Knowledge and the Discovery of Entrepreneurial Opportunities." *Organization Science*, Vol 11, No. 4, Pp. 448-469 (2000).
- Simon, Herbert. "Bounded Rationality and Organizational Learning." *Organization Science*, Vol. 2, No. 1, Pp. 125-134 (1991).
- Stearns, T. and G. Hills. "Entrepreneurship and New Firm Development: A Definitional Introduction." *Journal of Business Research*, Vol. 36, No. 1, Pp. 1-4 (1996).

- United States Department of Energy. Energy, Efficiency, and Renewable Energy. www.eere.energy.gov/afdc/data/index.html (2012).
- United States Department of Agriculture. National Nutrient Database for Standard Reference. www.nal.usda.gov/fnic/foodcomp/cgi-bin/list_nut_edit.pl (2012).
- University of Michigan, Center for Sustainable Systems. “U.S. Wastewater Treatment Factsheet.” Pub No. CSS04-14 (2011).
- Vaghely, I.P. and P.A. Julien. “Are opportunities recognized or constructed? An Information Perspective on Entrepreneurial Opportunity Identification.” *Journal of Business Venturing*, Vol. 25, No. 1, Pp. 73-86 (2010).
- Walzer, Norman. “Introduction: Entrepreneurship in Community Development.” *Community Development*, Vol. 35, No. 1, (2004).
- Walzer, Norman. *The American Midwest: Managing Change in Rural Transition*. M.E. Sharp, Inc.: Armonk, NY (2003).
- Walzer, Norman. *Entrepreneurship and Local Development*. Lexington Books: Lanham, MD (2007).
- Walzer, Norman. Measuring Economic Development Outcomes. (Discussion Paper). Center for Governmental Studies at Northern Illinois University (2012).
- Wennekers, S. and Thurik, R. “Linking Entrepreneurship and Economic Growth.” *Small Business Economics*, Vol. 13, No. 1, Pp. 27-55 (1999).
- Ziemer, N., S. Long, B. Mackie, D. Gory. “Strategic Matching and Linkage Development for Business.” Under review by *International Information Management Association*, submitted Oct 2012.
- Ziemer, N., and S. Long. “Building Strategic Partnerships for Technology Entrepreneurship.” American Society of Engineering Management. Proceedings (2009).
- Ziemer, N., and S. Long. “A Virtual Incubator for Biobased Entrepreneurship.” ASEM Proceedings. American Society of Engineering Management. Proceedings (2010).

Ziemer, N. and S. Long. "Collaborative Networks as Innovation Accelerators."
Proceedings of the Industrial Engineering Research Conference (2009).

University of Illinois at Urbana-Champaign. The Illinois Sustainability Technology
Center. www.istc.illinois.edu (2012).

VITA

Norbert L. Ziemer II earned the Bachelor of Science degree in Mechanical Engineering at the University of Illinois at Urbana-Champaign in 1993. Ziemer earned the Master of Science in Management at National-Louis University in 1999. Beyond the Master's degree, Ziemer has completed additional graduate coursework at Northern Illinois University in marketing, entrepreneurial strategic management, and technology. Ziemer has work experience spanning a range of industrial sectors including automotive, construction and manufacturing. Additionally, he has engaged in business consulting and project management.

Ziemer is currently a Research Associate at Northern Illinois University within the Center for Governmental Studies (CGS). The CGS is a "think and do" tank with the purpose of increasing university engagement with the community and region. Ziemer's work in this role centers on research and development for collaborations leading to increased technology based business establishment and growth.

Ziemer also serves on the NIU faculty, teaching and conducting research in the Operations Management and Information Systems department at NIU. Ziemer received the Ph.D. in Engineering Management in December 2012.

